



YAMAHA PERSONAL RECEIVER

RP-U100

Owner's Manual

Thank you for purchasing the Yamaha RP-U100 Personal Receiver. In order to fully utilize the superior features of the Yamaha RP-U100 and to enjoy years of trouble-free operation, please read this *Owner's Manual* carefully before use.

Contents

Features	1	Using the Presets	12
Introduction	1	Storing Presets Manually	12
Virtual 3D	2	Storing Presets Automatically	12
Digital Sound Field Processing (DSP)	2	Selecting Presets	13
Controls and Functions	3	Copying Presets	13
Front Panel	3	Recording	14
Rear Panel	4	Using Sound Field Programs	15
Making Connections	5	Using RP-U100 Application	
Connecting your PC	5	Software	16
Connecting Audio Equipment	6	System Requirements	16
Connecting Speakers	7	Installing the RP-U100 Application	
Connecting an FM Antenna	8	Software	16
Connecting the AM Loop Antenna	8	Installing and Checking the Driver	17
Recommended Speaker Placement	8	Reinstalling the Driver Software	18
About the Display	9	Using the RP-U100 Application	
Selecting Audio Sources	10	Software and Online Help	19
Using the Tuner	11	Uninstalling the RP-U100 Application	
Locating Radio Stations Manually	11	Software	19
Locating Radio Stations Using Auto		Troubleshooting	20
Search	11	Supplied Accessories	22
		Specifications	23

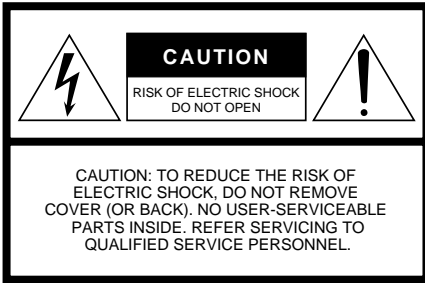

IMPORTANT!
Please record the serial number of this unit in the space below.

Model:
Serial No.:

The serial number is located on the rear of the unit.
Retain this Owner's Manual in a safe place for future reference.

• Explanation of Graphical Symbols



The lightning flash with arrowhead symbol, within an equilateral triangle, is intended to alert you to the presence of uninsulated "dangerous voltage" within the product's enclosure that may be of sufficient magnitude to constitute a risk of electric shock to persons.



The exclamation point within an equilateral triangle is intended to alert you to the presence of important operating and maintenance (servicing) instructions in the literature accompanying the appliance.

WARNING
TO REDUCE THE RISK OF FIRE OR ELECTRIC SHOCK, DO NOT EXPOSE THIS UNIT TO RAIN OR MOISTURE.

Safety Instructions

- 1 Read Instructions—All the safety and operating instructions should be read before the unit is operated.
- 2 Retain Instructions—The safety and operating instructions should be retained for future reference.
- 3 Heed Warnings—All warnings on the unit and in the operating instructions should be adhered to.
- 4 Follow Instructions—All operating and other instructions should be followed.
- 5 Water and Moisture—The unit should not be used near water – for example, near a bathtub, washbowl, kitchen sink, laundry tub, in a wet basement, or near a swimming pool, etc.
- 6 Carts and Stands—The unit should be used only with a cart or stand that is recommended by the manufacturer.
- 6A A unit and cart combination should be moved with care. Quick stops, excessive force, and uneven surfaces may cause the unit and cart combination to overturn.
- 7 Wall or Ceiling Mounting—The unit should be mounted to a wall or ceiling only as recommended by the manufacturer.
- 8 Ventilation—The unit should be situated so that its location or position does not interfere with its proper ventilation. For example, the unit should not be situated on a bed, sofa, rug, or similar surface, that may block the ventilation openings; or placed in a built-in installation, such as a bookcase or cabinet that may impede the flow of air through the ventilation openings.
- 9 Heat—The unit should be situated away from heat sources such as radiators, stoves, or other appliances that produce heat.
- 10 Power Sources—The unit should be connected to a power supply only of the type described in the operating instructions or as marked on the unit.
- 11 Power-Cord Protection—Power-supply cords should be routed so that they are not likely to be walked on or pinched by items placed upon or against them, paying particular attention to cords at plugs, convenience receptacles, and the point where they exit from the unit.



- 12** Cleaning—The unit should be cleaned only as recommended by the manufacturer.
- 13** When Not in Use—The power cord of the unit should be unplugged from the outlet when the unit is not used for a long period of time.
- 14** Object and Liquid Entry—Care should be taken so that no objects fall into, and liquids are not spilled into the unit.
- 15** Damage Requiring Service—The unit should be serviced by qualified service personnel when:
- A.** The power-supply cord or the plug has been damaged; or
 - B.** Objects have fallen, or liquid has been spilled into the unit; or
 - C.** The unit has been exposed to rain; or
 - D.** The unit does not appear to operate normally or exhibits a marked change in performance; or
 - E.** The unit has been dropped, or the enclosure damaged.
- 16** Servicing—The user should not service the unit beyond those means described in the operating instructions. All other servicing should be referred to qualified service personnel.
- 17** Overhead Power Lines—An outdoor antenna should be located away from overhead power lines.
- 18** Grounding or Polarization—Precautions should be taken so that the grounding or polarization is not defeated.
- 19** For US customers only:
Outdoor Antenna Grounding – If an outside antenna is connected to this unit, ensure the

antenna system is grounded so as to provide some protection against voltage surges and built-up static charges. Article 810 of the National Electrical Code, ANSI/NFPA 70, provides information with regard to proper grounding of the mast and supporting structure, grounding of the lead-in wire to an antenna discharge unit, size of grounding conductors, location of antenna discharge unit, connection to grounding electrodes, and requirements for the grounding electrode.

EXAMPLE OF ANTENNA GROUNDING

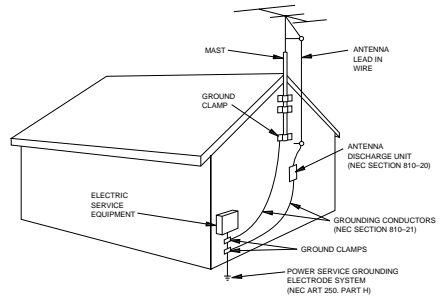

NEC – NATIONAL ELECTRICAL CODE

Note for CATV system installers:

This reminder is provided to call the CATV system installer's attention to Article 820-40 of the NEC that provides guidelines for proper grounding and, in particular, specifies that the cable ground shall be connected to the grounding system of the building, as close to the point of cable entry as practical.

We Want You Listening for a Lifetime

YAMAHA and the Electronic Industries Association's Consumer Electronics Group want you to get the most out of your equipment by playing it at a safe level. One that lets the sound come through loud and clear without annoying blaring or distortion – and, most importantly, without affecting your sensitive hearing.

Since hearing damage from loud sounds is often undetectable until it is too late, YAMAHA and the Electronic Industries Association's Consumer Electronics Group recommend you to avoid prolonged exposure to excessive volume levels.



COMPLIANCE INFORMATION STATEMENT

(DECLARATION OF CONFORMITY PROCEDURE)

Responsible Party: Yamaha Electronics Corp.,

Address: 6660 Orangethorpe Ave.

Buena Park, CA90620

Telephone: 714-522-9105

Type of Equipment: Receiver

Model Name: RP-U100

This device complies with Part 15 of the FCC Rules.

Operation is subject to the following conditions:

- 1) this device may not cause harmful interference, and
- 2) this device must accept any interference received including interference that may cause undesired operation.

See the user manual instructions if interference to radio reception is suspected.

FCC INFORMATION (U.S.A.)

1. IMPORTANT NOTICE: DO NOT MODIFY THIS UNIT!

This product, when installed as indicated in the instructions contained in this manual, meets FCC requirements. Modifications not expressly approved by Yamaha may void your authority, granted by the FCC, to use the product.

2. IMPORTANT: When connecting this product to accessories and/or another product use only high quality shielded cables. Cable/s supplied with this product MUST be used. Follow all installation instructions. Failure to follow instructions could void your FCC authorization to use this product in the USA.

3. NOTE: This product has been tested and found to comply with the requirements listed in FCC Regulations, Part 15 for Class "B" digital devices. Compliance with these requirements provides a reasonable level of assurance that your use of this product in a residential environment will not result in harmful interference with other electronic devices. This equipment generates/uses radio frequencies and, if not installed and used according to the instructions found in the users manual, may cause interference harmful to the operation of other electronic devices. Compliance with FCC regulations does not guarantee that interference will not occur in all installations. If this product is found to be the source of interference, which can be determined by turning the product "OFF" and "ON", please try to eliminate the problem by using one of the following measures:

Relocate either this product or the device that is being affected by the interference.

Utilize power outlets that are on different branch (circuit breaker or fuse) circuits or install AC line filter/s.

In the case of radio or TV interference, relocate/reorient the antenna. If the antenna lead-in is 300 ohm ribbon lead, change the lead-in to coaxial type cable.

If these corrective measures do not produce satisfactory results, please contact the local retailer authorized to distribute this type of product. If you can not locate the appropriate retailer, please contact Yamaha Electronics Corp., 6660 Orangethorpe Ave. Buena Park, CA90620

The above statements apply ONLY to those products distributed by Yamaha Corporation of America or its subsidiaries.



Manufactured under license from Dolby Laboratories. "Dolby", "Pro Logic" and the double-D symbol  are trademarks of Dolby Laboratories.

Intel and Pentium are registered trademarks and MMX is a trademark of Intel Corporation.

Windows is a registered trademark of Microsoft Corporation in the United States and/or other countries.

Read the Following Before Operating the Unit

1. To ensure the finest performance, please read this manual carefully. Keep it in a safe place for future reference.
2. Install this unit in a cool, dry, clean place – away from windows, heat sources, sources of excessive vibration, dust, moisture and cold. Avoid sources of hum (transformers, motors). To prevent fire or electrical shock, do not expose the unit to rain or water.
3. Never open the cabinet. If something drops into the unit, contact your dealer.
4. Do not use force with switches, controls or connection wires. When moving the unit, first disconnect the power plug and the wires connected to other equipment. Never pull the wires.
5. Do not touch the top cover, since it may become hot after extended high-power operation. This cover has openings for proper ventilation of the unit. Do not place any objects on these openings. If the openings are obstructed, the temperature inside the unit will rise rapidly. Also, be sure to install the unit vertically, not horizontally, in a well-ventilated area and allow enough clearance from the surrounding objects. Otherwise the receiver may be damaged or a fire may be caused.
6. The voltage used must be the same as that specified on this unit. Using this unit with a higher voltage than specified is dangerous and may result in fire or other accidents. YAMAHA will not be held responsible for any damage resulting from use of this unit with a voltage other than specified.
7. Digital signals generated by this unit may interfere with other equipment such as tuners, receivers, or TVs. Move this unit farther away from such equipment if interference is observed.
8. Always set the volume control to minimum before starting audio playback. Increase the volume gradually to an appropriate level after playback has been started.
9. Do not attempt to clean the unit with chemical solvents; this might damage the finish. Use a clean, dry cloth.
10. Be sure to read the “Troubleshooting” section regarding common operating errors before concluding that the unit is faulty.
11. When not planning to use this unit for long periods of time (i.e., vacation, etc.), disconnect the AC power plug from the wall outlet.
12. To prevent lightning damage, disconnect the AC power plug and disconnect the antenna cable when there is an electrical storm.

This unit is not fully disconnected from the AC power source as long as it is connected to the wall outlet, even if this unit itself is turned off. This state is called “standby mode.” In this mode, the unit consumes a small amount of electricity.

Features

- The RP-U100 Personal Receiver brings high-quality audio to your PC.
- The USB interface allows remote RP-U100 control from your PC, using the supplied RP-U100 Application Software, plus various audio I/O options.
- The built-in AM/FM stereo tuner offers 40 programmable presets.
- Yamaha's Near-Field Cinema DSP (Digital Sound Field Processing) technology and Virtual Dolby Digital provide live-music performance and movie-theater surround sound.
- Ideal for use with computer games, Internet music, CD-ROM, DVD, multimedia software, and more.

Introduction

Using Yamaha's unique DSP technology, the RP-U100 can bring excitement and realism to any audio source by simulating the acoustic environments of concert halls, movie theaters, and so on with only two speakers. With its stylish, vertical design, the RP-U100 allows you to use various audio sources, including your PC, CD player, MD or tape recorder, and the built-in AM/FM tuner, as shown below.

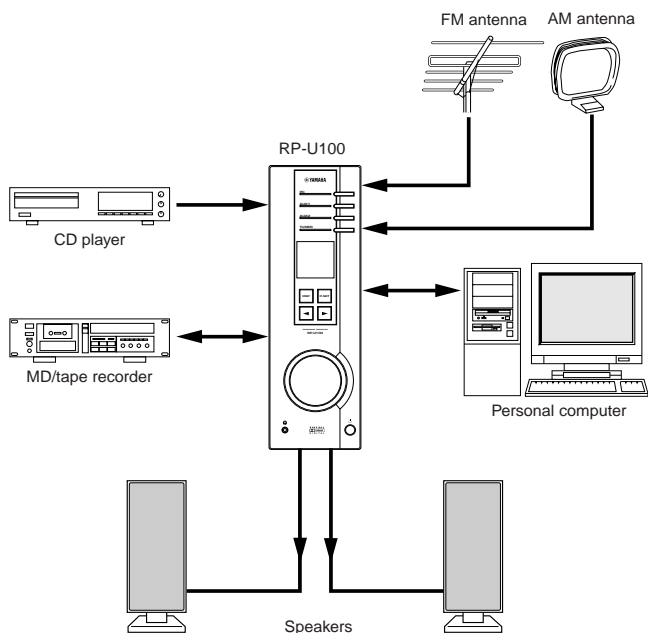

Although the RP-U100 can be used as part of a typical hi-fi system, connecting it to your PC via the USB port, and running the supplied RP-U100 Application Software, allows you to remotely control the RP-U100 from your PC and edit the sound field programs.

Virtual 3D

Surround sound typically requires several speakers situated in front of and behind the listening position, which requires a substantial amount of space that may not always be available. The RP-U100 uses Yamaha's unique "Virtual 3D" technology to simulate a typical surround sound system using only two speakers.

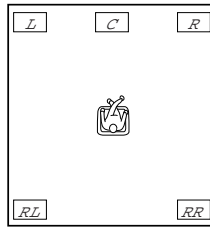

Typical surround system

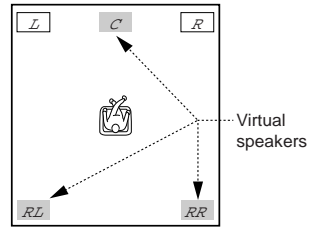

Virtual 3D

Virtual 3D, which is used by the RP-U100's sound field programs, simulates the surround effect provided by rear and center speakers, creating "virtual" surround speakers, as shown, so even with only two front speakers, you can still enjoy surround sound.

Digital Sound Field Processing (DSP)

When you listen to a performance in a concert hall, jazz club, or other live music venue, you not only hear the direct sound coming from the musical instruments and singers, but also the "early reflections" and natural reverberation. Early reflections are the initial sound waves that bounce off the floor, ceiling, and walls. Natural reverberation is made up of sound waves that gradually attenuate as they bounce repeatedly off multiple surfaces.

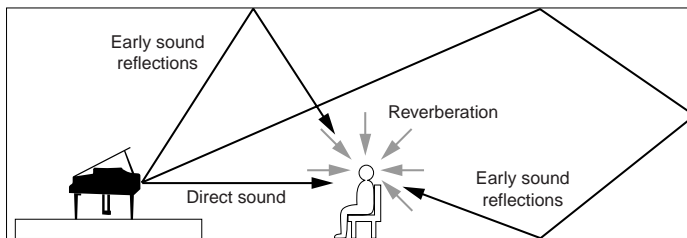

Since the way you hear early reflections and reverberation depends on the shape and size of the building as well as the material and construction of the walls and ceiling, each venue has its own unique "sound," called its "sound field." At Yamaha, we have measured all the elements that make up a typical sound field—direction and level of the reflections, bandwidth characteristics, and delay times—at famous concert halls and opera houses around the world. The information gained in this process has been converted into programs that can be reproduced using Yamaha's DSP technology. Using its on-board DSP, the RP-U100 can process any audio source and recreate the atmosphere of the original venue.

Controls and Functions

Front Panel

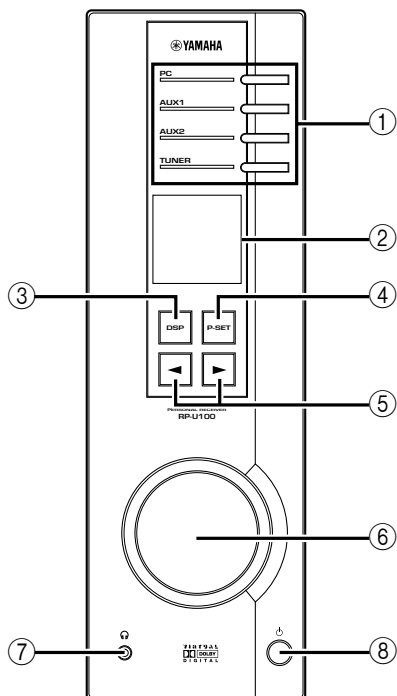

① Input selectors & indicators

These four keys, explained below, are used to select the input source. The indicator of the selected source lights up.

• PC key

This key selects your PC as the input source. The following inputs can be selected: USB port, ANALOG PC IN, DIGITAL PC COAX IN, or DIGITAL PC OPT IN. The DIGITAL PC OPT IN has priority over the DIGITAL PC COAX IN, so if you connect to both inputs, the signal received at the DIGITAL PC OPT IN is used.

• AUX1 key

This key selects the equipment connected to the ANALOG AUX 1 IN or DIGITAL AUX 1 OPT IN connector as the input source. The DIGITAL AUX 1 OPT IN has priority over the ANALOG AUX 1 IN, so if you connect to both inputs, the signal received at the DIGITAL AUX 1 OPT IN is used.

• AUX2 key

This key selects the equipment connected to the ANALOG AUX 2 IN connectors as the input source.

• TUNER key

This key selects the AM and FM bands of the built-in tuner as the input source. The following bands can be selected: FM Auto Stereo, FM Mono, or AM.

② Display

The display shows various settings, selected input source, sound field program, and various other information.

③ DSP key

This key activates the sound field programs produced by the internal DSP.

④ P-SET (Preset) key

This key selects the following tuner modes: Frequency Display mode and Preset mode.

- **Frequency Display mode:** In this mode, the radio frequency is displayed and you can tune the AM/FM tuner either manually or automatically.
- **Preset mode:** In this mode, you can select preset stations A1 through E8.

The 40 presets are arranged into five groups from A through E, with eight presets in each group.

⑤ ◀/▶ (Down/Up) keys

These keys are used to select sound field programs, preset stations, and tune the AM/FM tuner.

⑥ Volume control

This control adjusts the speaker and headphone volume.

⑦ Headphone jack

Stereo headphones can be connected to this mini-jack for private listening, with Virtual 3D effects specifically tailored for headphone listening.

⑧ Power switch

This switch is used to turn on the RP-U100 or set it to standby mode. In standby mode, the RP-U100 can be turned on remotely from your PC, using the supplied RP-U100 Application Software. Note that the RP-U100 uses a small amount of power in standby mode.

Rear Panel

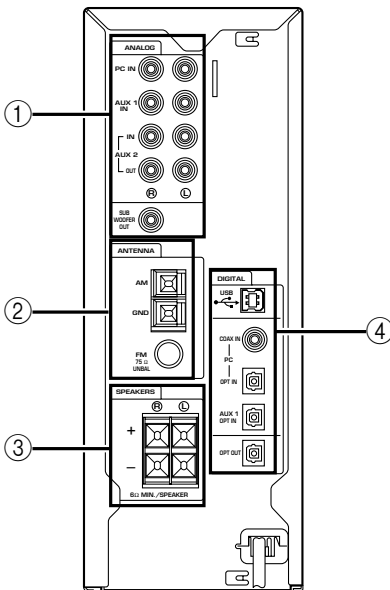

① ANALOG inputs & outputs

These connectors are used to connect to the analog inputs and outputs of a PC sound card, CD player, or MD/tape recorder. The SUB WOOFER OUT can be connected to an optional subwoofer, such as the Yamaha YST-SW45, for enhanced bass performance.

② ANTENNA

These connectors are used to connect AM and FM antennas.

③ SPEAKERS

These connectors are used to connect a pair of speakers, such as the Yamaha NS-U50.

④ DIGITAL inputs & outputs

These connectors are used to connect to the digital inputs and outputs of a PC sound card, CD player, or MD recorder. If your PC has a USB port, connect it to the RP-U100 using the supplied USB cable, for remote RP-U100 control from your PC.

Making Connections

Connection Notes

- Turn off the RP-U100 and all equipment to be connected before making any connections.
- Refer to the owner's manuals supplied with your other equipment for more information.

Connecting your PC

If your PC has a USB port, connect it to the RP-U100's USB port using the supplied USB cable, as shown below. A single USB connection is all that's required to listen to audio from your PC on the RP-U100, feed audio from an external source connected to the RP-U100 to your PC, and control the RP-U100 remotely from your PC, using the supplied RP-U100 Application Software.

Note: Make sure that the USB cable is disconnected from the RP-U100 before installing the RP-U100 Application Software. See page 16 for more information.

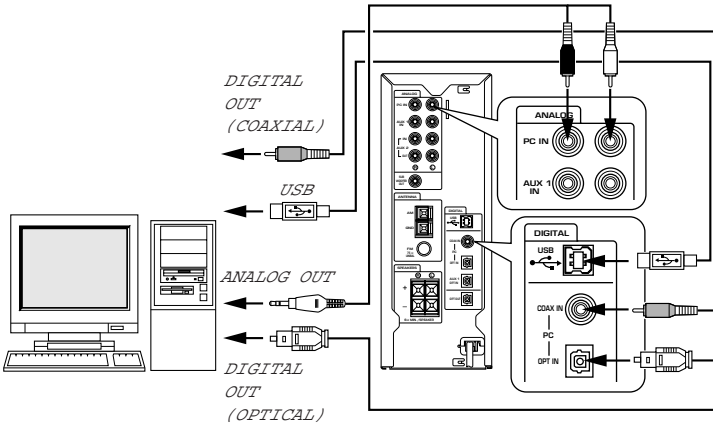

If your PC doesn't have a USB port, you can still connect it to the RP-U100 using the analog and digital inputs and outputs, but cannot use the RP-U100 Application Software. Audio from your PC can be fed to the RP-U100 using any of following connectors: USB (as explained above), DIGITAL PC COAX IN, DIGITAL PC OPT IN, or ANALOG PC IN.

To play DVD-Video discs encoded with Dolby Digital, your computer must have a DVD-ROM drive and DVD-Video decoder board, which should be connected to the RP-U100 via the DIGITAL PC COAX IN or DIGITAL PC OPT IN.

Note: The DIGITAL PC OPT IN has priority over the DIGITAL PC COAX IN, so if you connect to both inputs, the signal received at the DIGITAL PC OPT IN is used.

Connecting Audio Equipment

The following illustration shows how to connect a CD player and MD or tape recorder. The CD player is shown connected to the RP-U100 using both analog and digital connections. However, it's not necessary to make both connections. Since digital offers higher quality, use the digital connection if your CD player had a digital output. The MD/tape recorder is shown connected to the RP-U100 using analog and digital connections. If your MD player has a digital input, connect it as shown. Be careful not to mix up the left and right connections.

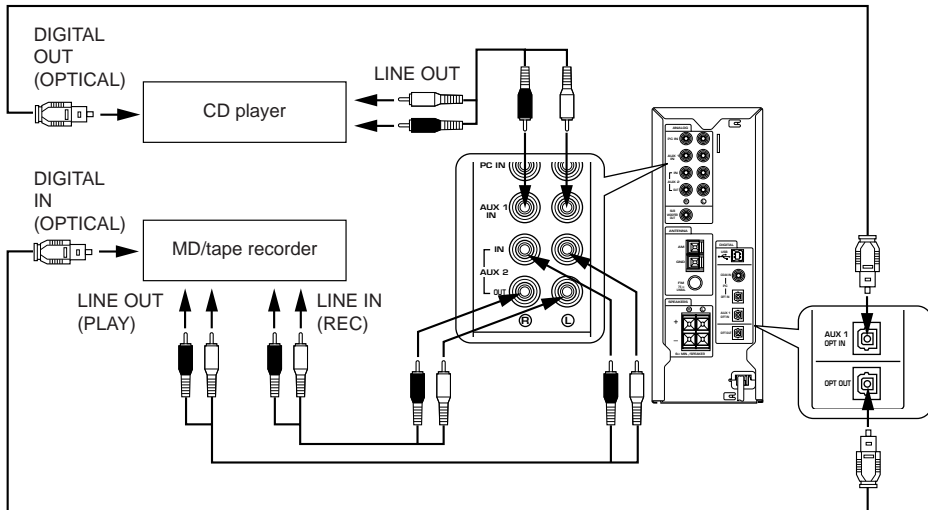

Note: The DIGITAL AUX 1 OPT IN has priority over the ANALOG AUX 1 IN, so if you connect to both inputs, the signal received at the DIGITAL AUX 1 OPT IN is used.

Protective Caps

When connecting to an optical connector, remove its protective cap first. When an optical connector is not being used, replace its cap to prevent dust entering the connector.

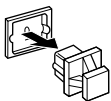

Connecting Speakers

The following illustration shows how to connect a pair of speakers and subwoofer. Connect the left speaker to the left speaker connector on the RP-U100 and the right speaker to the right speaker connector, and pay careful attention to the plus and minus polarities.

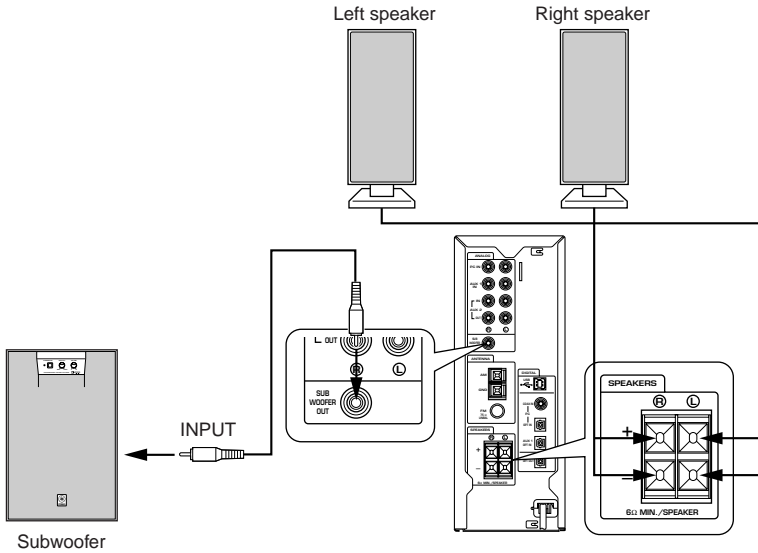

Speaker Cables

Strip 10 mm of insulation off the end of each speaker cable, and then twist the bare wires to prevent loose strands, which can cause short circuits.

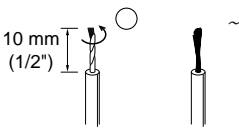

Speaker Connectors

Flip open the speaker connector levers, insert the bare ends of the speaker cables into the terminal holes, then close the levers. Try pulling gently on each cable to make sure that it's secure.

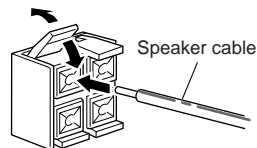

Connecting an FM Antenna

Connect an FM antenna to the FM ANTENNA connector (FM 75Ω UNBAL).

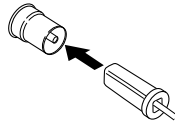

Use the supplied indoor FM antenna only in areas with exceptionally good reception. Use the supplied F-type adapter to connect an outdoor FM antenna with an F-type connector.

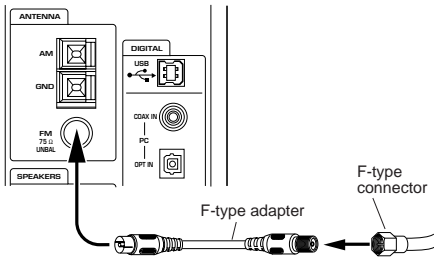

Connecting the AM Loop Antenna

1. Flip open the AM and GND ANTENNA connector levers.
2. Insert the AM antenna cable into the AM and GND connectors. (Polarity is not important.)
3. Close the levers to secure the cable.
4. Site the AM loop antenna away from the PC and monitor.
5. Rotate the antenna to find the position that offers the best reception.

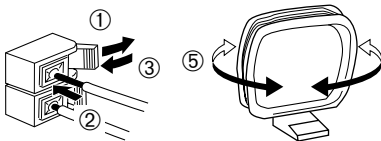

Recommended Speaker Placement

For best performance, place the left and right speakers either side of your computer monitor, as shown below, and position them so that their fronts are flush. To get the best from the sound field programs and surround effects, the left and right speakers and the listener should be positioned so as to form a triangle with a 3:4 ratio, so if, for example, the speakers are 60 cm (23.5") apart, the listener should be 80 cm (31.5") away from each speaker. Bass performance can be extended by connecting a subwoofer, such as the Yamaha YST-SW45, to the SUB WOOFER OUT.

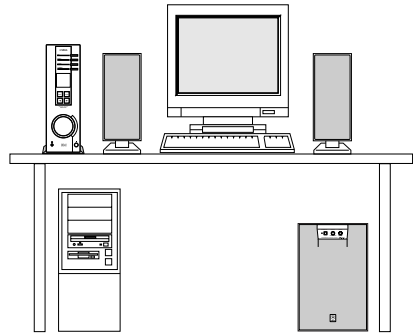

Recommend Listening Position

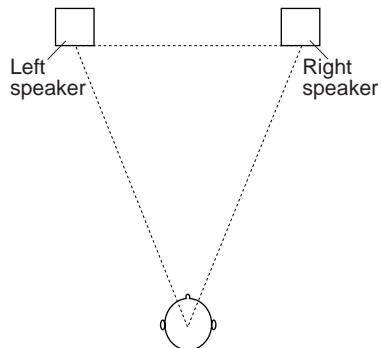

About the Display

This section explains what the various display indicators mean.

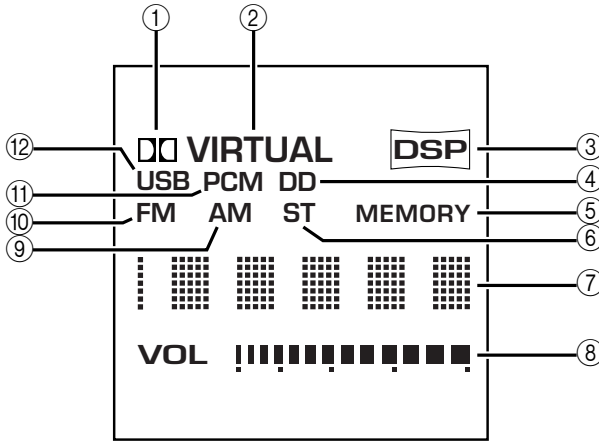

- ① **Dolb logo**
This indicator appears when the RP-U100 is decoding a Virtual Dolby Digital or Virtual Dolby Surround audio source. When the MOVIE, LIVE, GAME, or VDD program is selected, this indicator lights up regardless of the input source. It does not light up when headphones are used.
- ② **VIRTUAL**
This indicator appears when the RP-U100 is using Virtual 3D.
- ③ **DSP**
This indicator appears when the DSP is processing the input signal.
- ④ **DD (Dolby Digital)**
This indicator appears when a Dolby Digital encoded digital audio signal is selected as the input source.
- ⑤ **MEMORY**
This indicator flashes when a preset station is stored.
- ⑥ **ST (STEREO)**
This indicator appears when a stereo FM signal of sufficient strength is received.
- ⑦ **Message area**
Various messages and information appear here.
- ⑧ **VOL (volume)**
This indicator graphically displays the volume level setting.
- ⑨ **AM**
This indicator appears when the AM tuner is selected as the input source.
- ⑩ **FM**
This indicator appears when the FM tuner is selected as the input source.
- ⑪ **PCM**
This indicator appears when a PCM digital audio signal is selected as the input source.
- ⑫ **USB**
This indicator appears when audio signals are sent or received via the USB port.

Selecting Audio Sources

This section explains how to turn on the RP-U100 and select input sources. If any external audio equipment is connected to the RP-U100, turn it on first.

1. Press the POWER switch to turn on the RP-U100.

The message “Hello” appears for a few seconds, and the RP-U100 returns to the state in which it was last used (e.g., the input source that was selected when the RP-U100 was turned off is selected).



2. Use the input selector keys to select one of the following input sources.

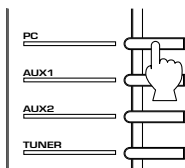

• PC

Press the PC key repeatedly to select the following PC inputs: USB, PC_DG, and PC_AN. USB selects the USB port, PC_DG selects the DIGITAL PC COAX IN and DIGITAL PC OPT IN, and PC_AN selects the ANALOG PC IN.

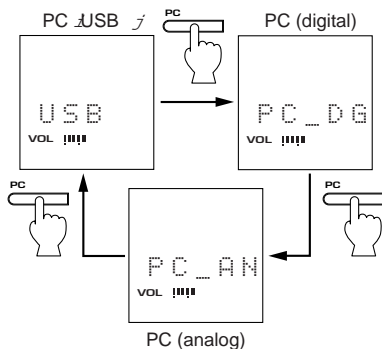

Note: The DIGITAL PC OPT IN has priority over the DIGITAL PC COAX

IN, so if you connect to both inputs, the signal received at the DIGITAL PC OPT IN is used.

• AUX1

Press the AUX1 key to select the equipment connected to the ANALOG AUX 1 IN or DIGITAL AUX 1 OPT IN connector as the input source.

Note: The DIGITAL AUX 1 OPT IN has priority over the ANALOG AUX 1 IN, so if you connect to both inputs, the signal received at the DIGITAL AUX 1 OPT IN is used.

• AUX2

Press the AUX2 key to select the equipment connected to the ANALOG AUX 2 IN connectors as the input source.

• TUNER

Press this key repeatedly to select the following tuner bands: FM Auto Stereo, FM Mono, or AM.

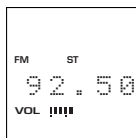

3. Start the selected input source.

See page 11 for more information about using the tuner.

4. Use the volume control to adjust the volume level.

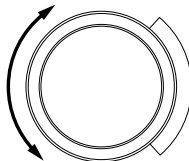

Using the Tuner

Locating Radio Stations Manually

1. Use the P-SET key to select Frequency Display mode.

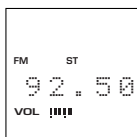

In Frequency Display mode, the radio frequency is displayed, as shown here.

2. Press the TUNER key repeatedly to select one of the following tuner bands: FM Auto Stereo, FM Mono, or AM.

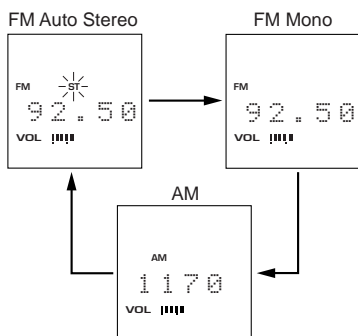

3. Use the Down [◀] and Up [▶] keys to locate radio stations.

Use the Down [◀] key to lower the frequency; the Up [▶] key to increase it.

Note: If there is noise in an FM Stereo broadcast, try switching to FM Mono.

Locating Radio Stations Using Auto Search

1. Press the TUNER key repeatedly to select one of the following tuner bands: FM Auto Stereo, FM Mono, or AM.

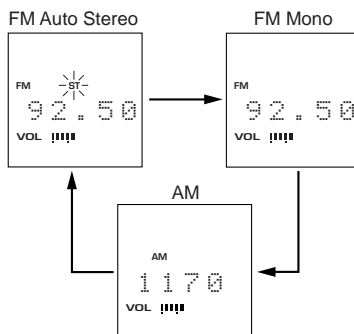

2. Use the P-SET key to select the Frequency Display mode.

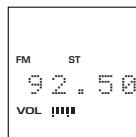

Frequency Display mode

In Frequency Display mode, the radio frequency is displayed, as shown here.

3. Press and hold the Down [◀] or Up [▶] key to start Auto Search.

Auto Search starts from the current radio frequency. Use the Down [◀] key to search down; the Up [▶] key to search up. The RP-U100 stops searching when it locates a station. To search for another station, repeat step 3.

Note: If Auto Search cannot locate a station due to its weak signal, try locating the station manually.

Using the Presets

You can store your favorite radio stations in the 40 presets, which are organized into five groups (A–E), with eight presets in each group. Preset “B3,” for example, is preset number 3 of group B.

Storing Presets Manually

1. Locate the radio station that you want to store, as explained on page 11.
2. Press and hold the P-SET key until “MEMORY” flashes on the display.

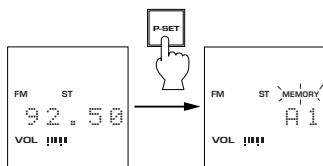

3. While “MEMORY” is flashing, use the P-SET key to select a preset group from A through E, and the Down [◀] and Up [▶] keys to select a preset number from 1 through 8. Then press and hold the P-SET key until the number of the selected preset flashes. The preset is stored. See page 13 for information on selecting presets.

Storing Presets Automatically

The Auto Preset function searches for all the radio stations available in your area and stores them in presets automatically.

Note: In steps 3 and 5, you have 10 seconds in which to make your selection. If you do not press a key within that time, Auto Preset will be cancelled and you’ll have to start again.

1. Press the TUNER key repeatedly to select one of the following tuner bands: FM Auto Stereo, FM Mono, or AM.
2. Press and hold the P-SET key until “AutoP” appears on the display. After a few seconds, “A1–E8” appears on the display. This is the range of presets that will be used to store stations. You can specify the first preset (initially A1) as follows. The last preset (E8) cannot be changed.
3. While “A1–E8” is displayed, use the P-SET key to select a preset group from A through E, and the Down [◀] and Up [▶] keys to select a preset number from 1 through 8.
4. Press and hold the P-SET key until “START” appears on the display.
5. While “START” is displayed, press the Down [◀] or Up [▶] key to start the Auto Preset function.

Auto Preset starts from the current radio frequency. Use the Down [◀] key to search down, and the Up [▶] key to search up. When a radio station is located, the RP-U100 stores it to the next available preset. Auto Preset stops when the entire band has been searched.

Note: When a preset is stored by the Auto Preset function, the previously stored radio station is overwritten. To protect radio stations stored, for example, in presets A1 through A4, specify A5 as the first preset, as explained previously.

Selecting Presets

1. Use the P-SET key to select Preset mode, as shown below.

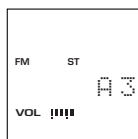

Preset mode

2. Use the P-SET key to select a preset group from A through E.
3. Use the Down [◀] and Up [▶] keys to select a preset number from 1 through 8.
The radio station stored in the preset is selected.
4. Press the TUNER key to check the frequency of the radio station.
The frequency is displayed for a few seconds.

Note: If there is noise in an FM Stereo broadcast, store the preset again using FM Mono.

Copying Presets

Once stored, presets can be arranged using the Preset Copy function. You may, for example, want to copy your favorite radio station to preset A1.

1. Use the P-SET key to select Preset mode, as shown below.

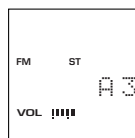

Preset mode

2. Use the P-SET key to select the preset group, and the Down [◀] and Up [▶] keys to select the preset number of the preset you want to copy.
3. Press and hold the P-SET key until “MEMORY” flashes on the display.
4. While “MEMORY” is flashing, use the P-SET key to select the preset group, and the Down [◀] and Up [▶] keys to select the preset number of the destination preset. Then press and hold the P-SET key until the group and number (e.g., “B3”) of the preset be copied flashes on the display.
The preset is copied.

Recording

The input source selected on the RP-U100 is output by the ANALOG AUX 2 OUT, DIGITAL OPT OUT, USB port, and speakers, as shown in the following table. “O” means that a signal is output, “X” means no signal is output.

Input Source			Output		
Input Selector	Display	Input Connector	ANALOG AUX 2 OUT	DIGITAL OPT OUT	USB
PC	USB	USB port	O	X	X
	PC_DG*1	DIGITAL PC OPT IN*2	X	O	X
		DIGITAL PC COAX IN	X	O	X
PC_AN*3	ANALOG PC IN	O	X	X	
AUX1	AUX-1	DIGITAL AUX 1 OPT IN*4	X	O	X
		ANALOG AUX 1 IN	O	X	O
AUX2	AUX-2	ANALOG AUX 2 IN	X	X	O
TUNER	AM or FM	—	O	X	O

*1 Signals received at the ANALOG PC IN are fed through to the ANALOG AUX 2 OUT.

*2 Has priority over the DIGITAL PC COAX IN.

*3 Signals received at the DIGITAL PC OPT IN or DIGITAL PC COAX IN are fed through to the DIGITAL OPT OUT.

*4 Has priority over the ANALOG AUX 1 IN.

By connecting a cassette tape recorder or MD recorder to the ANALOG AUX 2 OUT or DIGITAL OPT OUT, you can record from an external audio source (e.g., PC or CD player) or the tuner. When the input source is the ANALOG AUX 1 IN, ANALOG AUX 2 IN, or tuner, the input signal can be fed to your PC via the USB connection. Since sound field effects are not output by these connectors, they cannot be recorded.

- 1. Connect a tape recorder to the ANALOG AUX 2 OUT, or an MD recorder to the DIGITAL OPT OUT, as explained on page 6.**
- 2. Turn on the recorder and the RP-U100.**
- 3. Use the input selector keys to select an input source, as explained on page 10.**
See page 11 for more information about using the tuner.
- 4. Start recording on your tape or MD recorder.**
- 5. Start the input source.**

Using Sound Field Programs

The RP-U100's built-in DSP can simulate various acoustic environments, including a concert hall and movie theater, with its seven sound field programs. For best results, choose a program appropriate for the selected audio source.

1. Press the DSP key to turn on the sound-field processor.

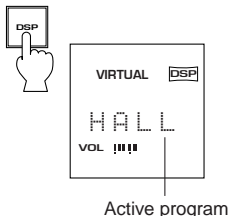

2. Use the Down [◀] or Up [▶] key to select a sound field program.

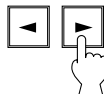

3. Press the DSP key to turn off the sound field processor. "THRU" appears on the display.

The name of the selected sound field program appears on the display.

The following programs are available.

Type	Program	Description	Notes
Virtual Dolby Digital	VDD	This program simulates the effect of Dolby Digital and is ideal for DVD software encoded using Dolby Digital.	When headphones are connected, this program changes to a simulation program called HP3D, which is specifically tailored for headphone listening.
Sound field programs for Audio Visual	MOVIE	The realism provided by this program gives the impression that you're actually in the scene.	For these sound field programs, a Yamaha DSP effect is applied to Dolby Pro Logic, Dolby Digital, and other surround sounds for motion-picture audio.
	LIVE	This program produces an enthusiastic atmosphere and lets you feel that you are in the midst of the action, as if attending an actual jazz or rock concert.	
	GAME	This program adds depth and surround effects to computer games, enhancing the gaming experience.	
Sound field programs for music	HALL	This program simulates the sound field of a medium-sized hall, with a beautiful and rich reverberation.	These programs create a sound field that feels real, just as if you were actually there.
	JAZZ	This program simulates the sound field of a famous New York jazz club.	
	CHRCH	This program simulates the sound field of a Gothic church, with the unique effect of sound reverberating back and forth in a domed ceiling.	

Using RP-U100 Application Software

This section explains how to install the RP-U100 Application Software, which can be used to control the RP-U100 from a PC running Windows 98. Instructions for using the RP-U100 Application Software are available as online help.

System Requirements

- A computer with a 200 MHz or faster Intel Pentium MMX processor or equivalent
 - At least 32 MB of RAM (64 MB or more recommended)
 - A hard disk with at least 20 MB of free space
 - A CD-ROM or DVD-ROM drive (installation only)
 - A VGA monitor (640 × 480, 256 color minimum)
 - A USB port (USB Ver 1.0 compatible)
 - Windows 98
-

Installing the RP-U100 Application Software

This section explains how to install the RP-U100 Application Software.

Installation Notes

- **Make sure that the USB cable is disconnected from the RP-U100. Do not connect the RP-U100 to the PC's USB port until the installation is complete, as the driver software will not be installed correctly and you will have to install it again, as explained on page 18.**
 - Make sure that your PC meets the system requirements listed previously.
 - You may be requested to insert your Windows 98 CD-ROM during the installation, so have it ready before commencing.
- 1. Turn on your PC and, if it's not running already, start Windows 98.**
 - 2. Insert the YAMAHA RP-U100 CD-ROM into the CD-ROM or DVD-ROM drive.**
 - If the Windows 98 Autorun feature is turned on, the installation start up screen appears automatically.
 - 3. Continue with the installation as prompted.**
 - If the Windows 98 Autorun feature is not turned on, you must start the installation manually, as explained below.
 - 4. Double-click the My Computer icon.**
 - The My Computer window opens.
 - 5. Double-click the "Yamaha rp-u100" CD-ROM icon.**
 - The installation start up screen appears.
 - 6. Continue with the installation as prompted.**

Installing and Checking the Driver

This section explains how to install the driver software and confirm that it has been installed correctly. When the RP-U100 is connected to the PC's USB port, Windows 98 automatically detects it and installs the necessary driver software. Windows 98 needs the driver software in order to communicate with the RP-U100.

1. Make sure that the RP-U100 power cable is plugged into an AC outlet.
The RP-U100 can be on or in standby mode when installing the driver.

2. Connect the RP-U100 to a USB port on the PC using the supplied USB cable.

Windows 98 automatically detects the RP-U100 and installs the necessary driver software. You may be requested to insert your Windows 98 CD-ROM. Next you need to confirm that the driver software has been installed correctly.

3. Click the Windows 98 “Start” button and select Settings, Control Panel.
The Control Panel window appears.

4. Double-click the System icon.
The System Properties window appears, as shown.

5. Click the Device Manager tab.
The Device Manager window appears.

6. Click the View devices by type option button.

7. Click the “+” symbol next to “Human Interface Devices,” and make sure that “YAMAHA RP-U100 HID Audio Controls” appears in the list, as shown.

8. Click the “+” symbol next to “Sound, video and game controllers,” and make sure that “YAMAHA RP-U100 USB Audio” appears in the list, as shown.

9. Click the “+” symbol next to “Universal serial bus controller” and make sure that “YAMAHA RP-U100 Composite USB Device” appears in the list, as shown.

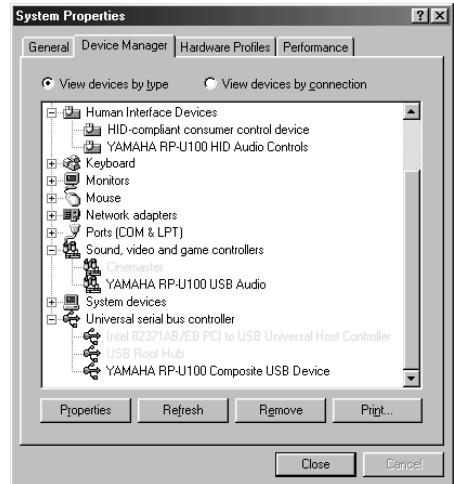

Note: The device list on your PC may differ to that shown here.

Reinstalling the Driver Software

If you connect the RP-U100 to the PC's USB port before installing the supplied application software, the RP-U100 driver software will not be installed correctly and the System Properties window will display the following items:

- “USB Audio Device” in the Sound, video and game controllers list
- “USB Human Interface Device” in the Human Interfaces list
- “USB Composite Device” in the Universal serial bus controllers list

Although you will be able to control the application software and listen to music, you must reinstall the RP-U100 device driver if you want the PC to recognize the RP-U100 correctly, as explained below.

1. Make sure that the RP-U100 is connected to the PC's USB port.
2. On the System Properties window, click the “+” symbol next to “Universal serial bus controller.”
3. Select “USB Composite Device.”

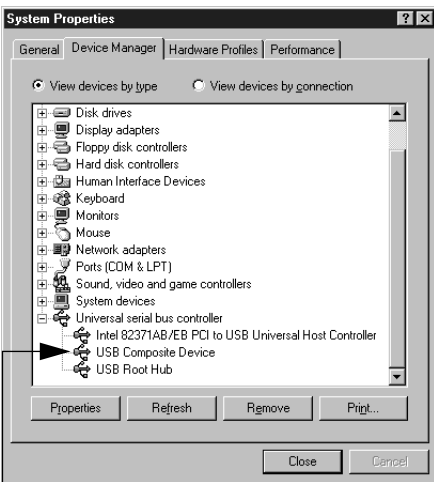

Select “USB Composite Device.”

4. Click Delete. The dialog box shown on the below appears.



5. Click OK to delete.
6. Confirm that “USB composite device” has been deleted from the list of Universal serial bus controllers.
7. Disconnect the USB cable from the PC.
8. Insert the YAMAHA RP-U100 CD-ROM into the CD-ROM or DVD drive and reinstall the driver software.
9. Check that the driver software has been installed correctly, as explained on page 17.

Using the RP-U100 Application Software and Online Help

This section explains how to start the RP-U100 Application Software and view the online help.

- 1. Click the Windows 98 “Start” button and select Programs, YAMAHA RP-U100, RP-U100.**
The RP-U100 Application Software starts.
- 2. To view the online help, click the Windows 98 “Start” button and select Programs, YAMAHA RP-U100, Help.**
The online help, which explains how to use the RP-U100 Application Software, starts.

Uninstalling the RP-U100 Application Software

This section explains how to uninstall the RP-U100 Application Software.

- 1. Quit the RP-U100 Application Software and online help.**
- 2. Click the Windows 98 “Start” button and select Settings, Control Panel.**
The Control Panel window appears.
- 3. Double-click the Add/Remove Programs icon.**
The Add/Remove Programs Properties window appears.
- 4. Select “YAMAHA RP-U100” in the software list.**
“YAMAHA RP-U100” is highlighted.
- 5. Click the Add/Remove button and continue as prompted.**

Troubleshooting

Important Information About Using the FM/AM Tuner

Computer equipment uses high-frequency digital circuits that may cause interference on radio and television equipment located nearby. If interference is a problem with the RP-U100, and you cannot obtain good reception, or the auto tuning functions don't work properly, try the following.

- Move the indoor FM or AM loop antenna as far away from the computer and monitor as physically possible and find the position and direction at which reception is the best.
- FM outdoor antennas offer the best performance and should be used when the good reception is not available. Be sure to use coaxial cable to connect to an outdoor antenna. Use the supplied F-type adapter to connect an outdoor FM antenna with an F-type connector.
- If you cannot obtain good AM reception using only the AM loop antenna, connect 5 to 10 meters (16 to 32 ft.) of ordinary PVC coated wire to the AM connector on the RP-U100, feed it through a window, or other outlet, and extend it horizontally. Be sure to also connect the AM loop antenna. Using another piece of wire, connect the GND connector on the RP-U100 to a good ground point, such as a grounding rod. Never connect the RP-U100 to a metal gas or oil pipe, which would cause a safety hazard, or a plastic water pipe.

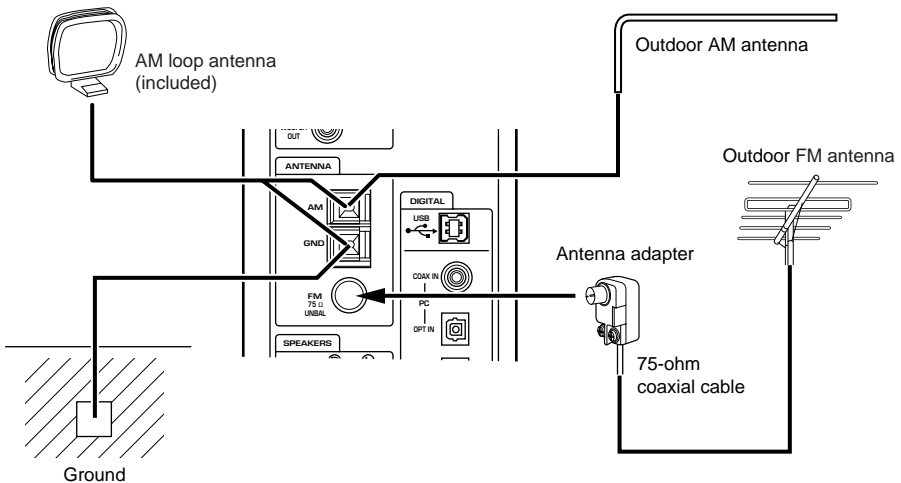

If your RP-U100 does not operate as expected, check the items below.

Symptom	Possible Cause	Remedy
Pressing the POWER switch does not turn on the RP-U100.	The power plug is not plugged into the wall outlet correctly.	Insert the power plug correctly.
	A speaker cable is shorted.	Switch off the power, correct the speaker connections, then switch on the power again.
There is no sound.	No input source is selected.	Select the source that you want to listen to.
		When using the PC input source, be sure to select the correct input: USB, digital, or analog.
	A connection is incorrect.	Check the connections.
The sound field programs have no effect.	The DSP is off.	Switch on the DSP.
There is a humming noise.	An analog connection is incorrect.	Insert the analog plugs correctly.
Using the RP-U100 affects TV reception or the performance of other equipment.	These equipment may be situated too close to the RP-U100.	Move these equipment away from the RP-U100.
The Presets do not work.	The preset settings are lost if the RP-U100 is unplugged for more than two weeks.	Reprogram the presets.

• Troubleshooting the FM Tuner

Symptom	Possible Cause	Remedy
A popping noise can be heard.	Interference from the ignition system of a motorcycle or automobile is being picked up.	Adjust the angle and location of the FM antenna to minimize the noise. If that does not eliminate the noise, install an outdoor FM antenna.
		Use a coaxial cable for the antenna connection.
Stereo broadcasts are accompanied by an unpleasant background noise.	The antenna signal is too weak or the signal of the station you are receiving is weak.	Install an outdoor FM antenna.
Auto tuning cannot locate a station.	The station is too weak.	Use a multi-element antenna.
		Use manual tuning.

• **Troubleshooting the AM Tuner**

Symptom	Possible Cause	Remedy
The station can hardly be heard or the sound quality is poor.	The signal is weak or the antenna connection is incomplete.	Adjust the direction of the AM loop antenna. If that does not improve the sound, adjust the angle and location of the antenna to find the optimum position.
Auto tuning cannot locate a station.	The station is too weak.	Try reconnecting the AM loop antenna.
		Use manual tuning.
A continuous popping noise can be heard.	Interference noise is being caused by lightning, a fluorescent light, a motor, or electrical equipment with a thermostat.	Use an outdoor AM antenna.
		Make sure that all electrical equipment is grounded correctly. In some situations, it may be difficult to completely eliminate this problem.

Supplied Accessories

• **AM loop antenna**

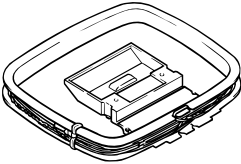

• **Indoor FM antenna**

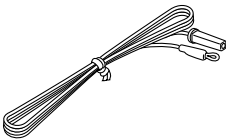

• **Adapter for F-type antenna connector**

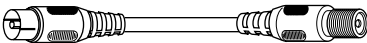

• **USB cable**

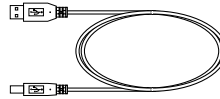

• **CD-ROM**

The CD-ROM contains the RP-U100 Application Software, and online help, for controlling the RP-U100 from your PC.

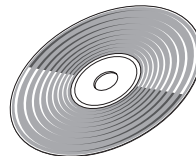

Specifications

Minimum RMS Output	
Power per Channel:	30 W + 30 W (20 Hz–20 kHz, 6Ω, 0.6% THD)
Input Sensitivity:	
PC IN, AUX1 IN, AUX2 IN (Analog)	150 mV/35 kΩ
Output Level:	
AUX2 OUT	150 mV/3.3 kΩ
Subwoofer	2.0 V/1.5 kΩ
Headphone	330 mV/47Ω
Tuning Range:	FM 87.5–107.9 MHz AM 530–1710 kHz
Usable Sensitivity:	FM 1.5 μV AM 60 dBμ or less
Dimensions (W × H × D):	120 × 295 × 379.5 mm (4.7 × 11.6 × 15 inches)
Weight:	5.4 kg (11.9 lbs)

Specifications subject to change without notice.

YAMAHA ELECTRONICS CORPORATION, USA 6660 ORANGETHORPE AVE., BUENA PARK, CALIF. 90620, U.S.A.
YAMAHA CANADA MUSIC LTD. 135 MILNER AVE., SCARBOROUGH, ONTARIO M1S 3R1, CANADA
YAMAHA ELECTRONIK EUROPA G.m.b.H. SIEMENSSTR. 22-34, 25462 RELINGEN BEI HAMBURG, F.R. OF GERMANY
YAMAHA ELECTRONIQUE FRANCE S.A. RUE AMBROISE CROIZAT BP70 CROISSY-BEAUBOURG 77312 MARNE-LA-VALLEE CEDEX02, FRANCE
YAMAHA ELECTRONICS (UK) LTD. YAMAHA HOUSE, 200 RICKMANSWORTH ROAD WATFORD, HERTS WD1 7JS, ENGLAND
YAMAHA SCANDINAVIA A.B. J A WETTERGRENS GATA 1, BOX 30053, 400 43 VÄSTRA FRÖLUNDA, SWEDEN
YAMAHA MUSIC AUSTRALIA PTY, LTD. 17-33 MARKET ST., SOUTH MELBOURNE, 3205 VIC., AUSTRALIA

YAMAHA RP-U100 Application Help



How to Use Help

Company names and product names mentioned in the help are trademarks or registered trademarks of their respective owners.
Changes may be made in the help contents without prior notice.

EP-U100 Contents, Index, and Search

		FUNCTIONS
	Contents	Display the index by selecting the Contents tab on the move pane. The help contents are arranged hierarchically.

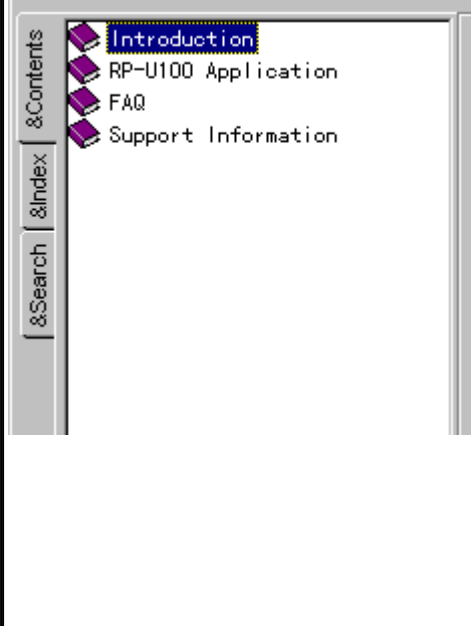
	<p>Contents hierarchically. Related items are arranged in sequence from the top on down, so you can visually select the page you need.</p>
<p>Index</p>	<p>Keywords (important terms) used in the help file are listed here. Keywords listed here can be directly selected or can be searched by entering that keyword.</p>
<p>Search</p>	<p>This function lets you search for any word or phrase contained in the help file. Enter the word you want to find, and a list of pages containing that word will be displayed. Select the related page you need from the page list to view its contents.</p>

RP-U100 The pointer changes to a hand when placed on an item that can be clicked.



Hand Symbol

- ☐ Clicking on the item indicated by the hand brings up a related page or image.
- ☐ Basic knowledge of Windows 98, Internet Explorer or similar software is needed to use the RP-U100 Application Help.
See "[Windows Help](#)" for more information on using Windows 98.

* Windows is a registered trademark of Microsoft Corporation in the United States and/or other countries.

Introducing the RP-U100

RP-U100 Personal Receiver RP-U100

The Personal Receiver RP-U100 is a USB compatible multimedia amplifier with built-in tuner. While it can of course be used as a conventional receiver, connecting the RP-U100 to a personal computer opens up a host of exciting possibilities for audio fun and entertainment.

RP-U100 Total Computer Control

[All RP-U100 functions can be operated from a PC](#) running the dedicated RP-U100 Application. A convenient USB link is used between the RP-U100 main unit and the computer.

RP-U100 Yamaha Digital Sound Field Processing

The RP-U100 incorporates various DSP sound field programs specially adapted for audio and multimedia applications. Using a wealth of stored data, the amp can faithfully reproduce the acoustic properties of world famous concert halls and live venues. Exciting theater type sound compatible with DVD movie formats such as [Dolby Digital](#) is also available.

RP-U100 Virtual 3D Gives the Feeling of "Being There"

Sophisticated Yamaha technology transports you right to where the action is. Usually several front and rear speakers are needed to reproduce multichannel sources such as Dolby Digital. The unique [Virtual 3D technology](#) developed by Yamaha produces a realistic surround effect with just two speakers placed left and right in front of the listener.

RP-U100 Compatible with a Wide Variety of Formats

The RP-U100 provides USB, digital, and analog input/output connectors for hookup of a computer and almost any type of audio equipment.

RP-U100 SB Capture

The RP-U100 also features a [USB capture function](#) for recording. An analog input signal supplied to the RP-U100 is converted to digital form and sent to the PC via the USB link. These data can then be recorded using dedicated recording software.

DOLBY DIGITAL (*1)

This is a theater acoustics format developed by Dolby Labs USA for home use. "Dolby Digital" is a method to reproduce completely independent audio utilizing digital compression technology on 5.1 channels consisting of 3 front channels and 2 rear channels for a total of 5 channels plus a low frequency effect channel. The conventional "Dolby Pro Logic" format 3 front channels and 1 rear channel mixed into 2 stereo channels, by a matrix circuit. Dolby Digital creates a 3-dimensional surround effect of superior quality.

(*1)

Manufactured under license from Dolby Laboratories.

"Dolby", "Pro Logic" and the double-D symbol  are trademarks of Dolby Laboratories.

Confidential Unpublished Works. *1992-1997 Dolby Laboratories. All rights reserved.

Virtual 3D Technology

Reproducing a Dolby Digital or Dolby Pro Logic source requires the use of a total of 4-6 speakers placed before and behind the listener, using a substantial amount of space that may not always be available.

The RP-U100 features Yamaha's unique "virtual 3D" technology for generating virtual surround using just two speakers. Even with only two front speakers, this technology produces a sensation of "virtual rear speakers" and provides a pleasant sense of width and motion of sound behind you.

You can also take advantage of this RP-U100 application to create virtual 3D parameters to match your personal taste.

USB Capture

RP-U100 USB Capture

For USB capture, analog signals input to the analog jacks on the RP-U100 are subjected to analog/digital (A/D) conversion and then output in digital form via the USB link to a personal computer. This function allows the digital data to be recorded on the computer, using an application such as a sound recorder.

RP-U100 Input jacks for data capture

Which input jacks are used for data capture depends on the mode selected with the input selector.

[Input selector details](#)



Mode	Input jacks used for data capture
AUX1	AUX1 - ANALOG jack
AUX2	AUX2 - ANALOG jack
TUNER	Internal tuner signal

! The USB capture function is not available in PC input mode.

RP-U100 Data Recording Methods

-  The RP-U100 Application does not include a recording function. Please use appropriate recording software installed on the computer. For information on how to use the software, please refer to its documentation.
- !** The sound recorded with the USB capture function is the original sound of the input signal. The effects of the DSP sound field programs of the RP-U100 are not recorded.
- !** The data format supplied to the computer is 44.1 kHz, 16 bit, stereo. Make sure that the recording software is set up properly to handle this format.
- !** While making a recording using USB capture, you should close all other applications running on the computer. Otherwise recording quality may be poor.

RP-U100 Note

-  Digital input signals cannot be captured.
-  If data capture is activated while using the AUX1 - DIGITAL inputs, the RP-U100 automatically switches to the AUX1 - ANALOG inputs. After capture has ended, the setting automatically returns to the AUX1 - DIGITAL inputs.

RP-U100 The RP-U100 can be operated either with the controls on the unit itself or with the Application installed on the computer.

! Some functions of the RP-U100 are available only from the Application.

RP-U100 The following list shows which functions are available on the RP-U100 main unit and the Application.

Function List		
O : Available X : Not available		
Function	Main unit	application
Power on/standby	O	O
Input (mode) select	O	O
Customizing input selector display	X	O
Volume adjustment	O	O
USB Mix Level	X	O
Mute	X	O
Level balance	X	O
Tuner Band (FM/AM)	O	O
Manual tuning	O	O
Auto tuning	O	O
Preset (Store - Call up - Edit)	O	O
Preset station frequency display	O	O
Auto preset	O	O
DSP On/Off	O	O
Sound field program selector	O	O
Parameter setting	X	O

- RP-U100** **Operating system**
Microsoft® Windows® 98 English version
- RP-U100** **CPU**
Equivalent to Intel Pentium MMX 200 MHz or better
- RP-U100** **Memory**
32 MB (64 MB or more recommended)
- RP-U100** **Hard disk**
20 MB of available space
- RP-U100** **CD drive**
CD-ROM drive or DVD-ROM drive
- RP-U100** **Display**
Video display adapter with at least 256 colors and 640x480 dots resolution
- RP-U100** **Other**
USB port compatible with USB standard Rev. 1.0
-

- * Intel and Pentium are registered trademarks and MMX is a trademark of Intel Corporation.
- * Windows is a registered trademark of Microsoft Corporation in the United States and/or other countries.

Initial Steps

RP-U100 **Check the USB connection between the RP-U100 and the PC.**

 Connect the RP-U100 to the personal computer using a USB cable.

[How to make the USB connection](#)

 The RP-U100 main unit can only be operated with the Application if the USB connection has been established.

RP-U100 **Check the display settings.**

Check that the Windows Display Properties are set to at least 256 colors.

[Windows Display Properties](#)

Making the USB Connection

Connection Procedure

1	Plug the power cable of the RP-U100 into an AC outlet to set the unit to On or Standby.
2	Start up the computer.
3	Connect the RP-U100 and computer with the USB cable.

Check the connection

1	Open Multimedia from the Windows Control Panel and select the Audio tag. Click here to open the Audio tag on the control panel.
2	Select "YAMAHA RP-U100 USB Audio" as the "Preferred Device" for playback and recording.
3	Start up the application and check that the RP-U100 is controlled by the application.
4	Play some audio on the computer (CD, MIDI, WAVE, etc.) and confirm that the RP-U100 reproduces the sound.

Disconnection Procedure

1	Set the RP-U100 to Standby or Off.
2	Turn off the power to the computer.
3	Disconnect the USB cable linking the RP-U100 with the computer.

RP-U100 Application Panels

Main Panel



This is as the main panel of the Application.
Allows you to switch the RP-U100 on and off, control basic functions, and access various other panels.

[Details](#)

Setup Dialog



Lets you set various system parameters.
[Details](#)

Tuner Panel
(Frequency Display)

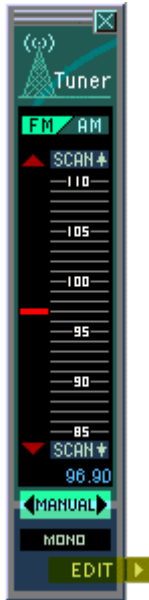

Lets you perform manual and scan tuning.
[Details](#)

Tuner Panel (Preset Display)



Lets you select preset stations.

[Details](#)

Preset Edit Panel

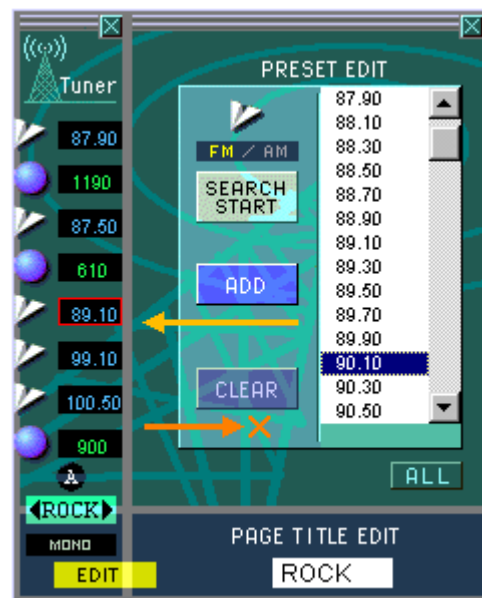

Lets you store stations in memory.

[Details](#)

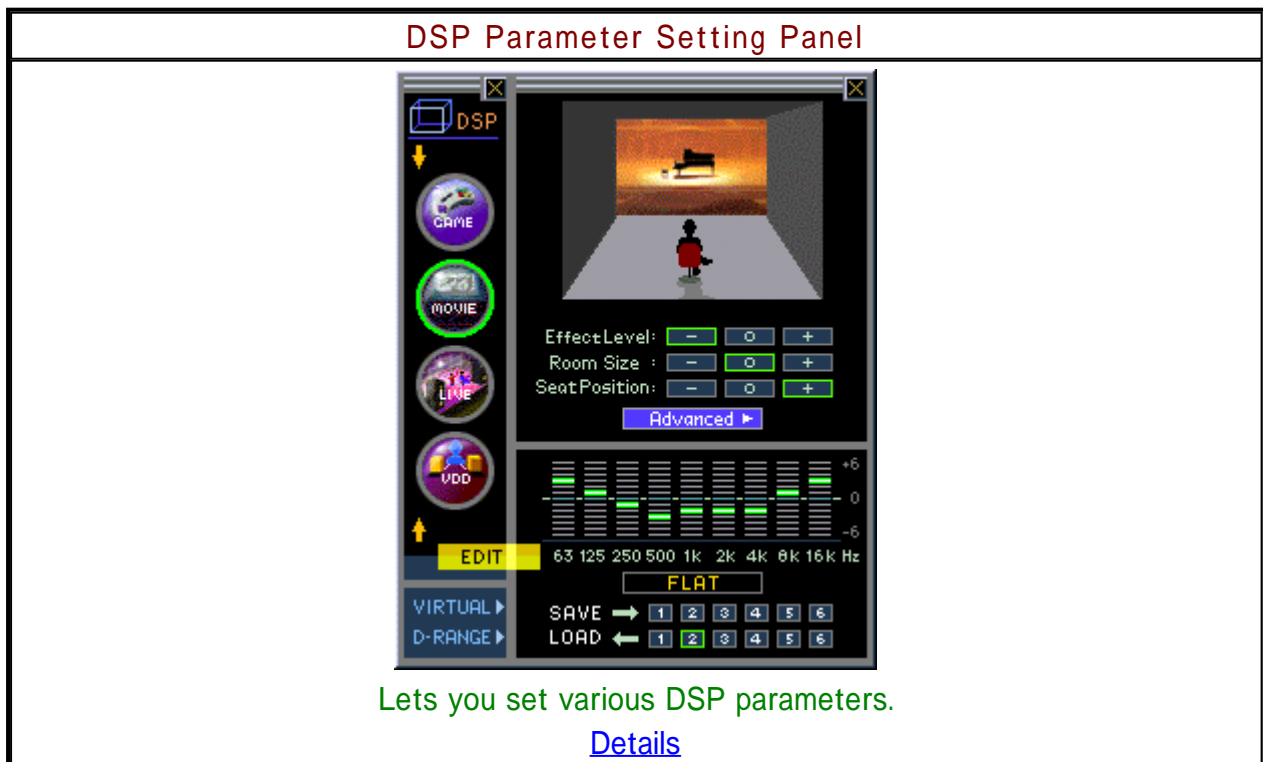
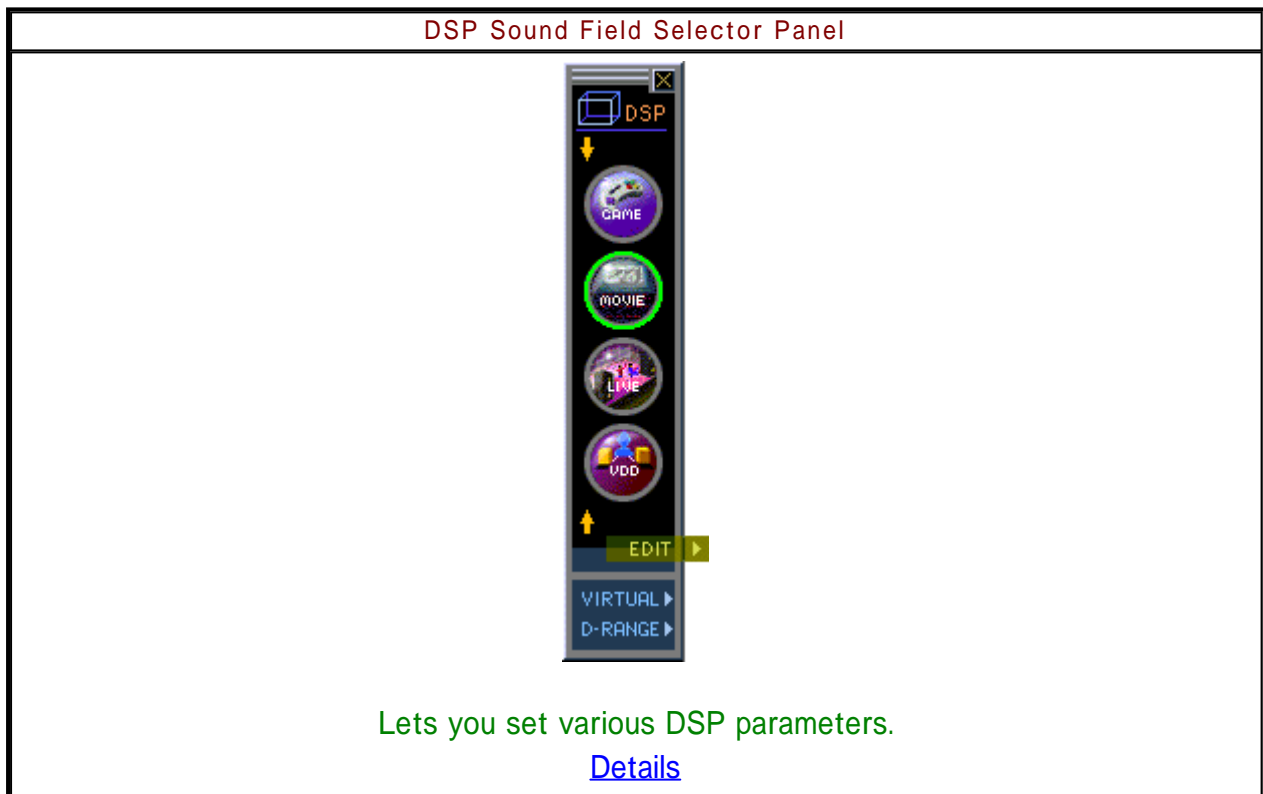

Virtual 3D Parameter Setting Panel



Lets you set various Virtual 3D parameters.

[Details](#)

Dynamic Range Setting Panel

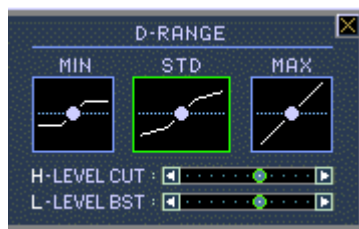

Lets you control the dynamic range.

[Details](#)

Quitting the Application

RP-U100 How to Quit the Application



Click the Close button  in the upper right corner of the main panel.

You can also quit the Application as follows.

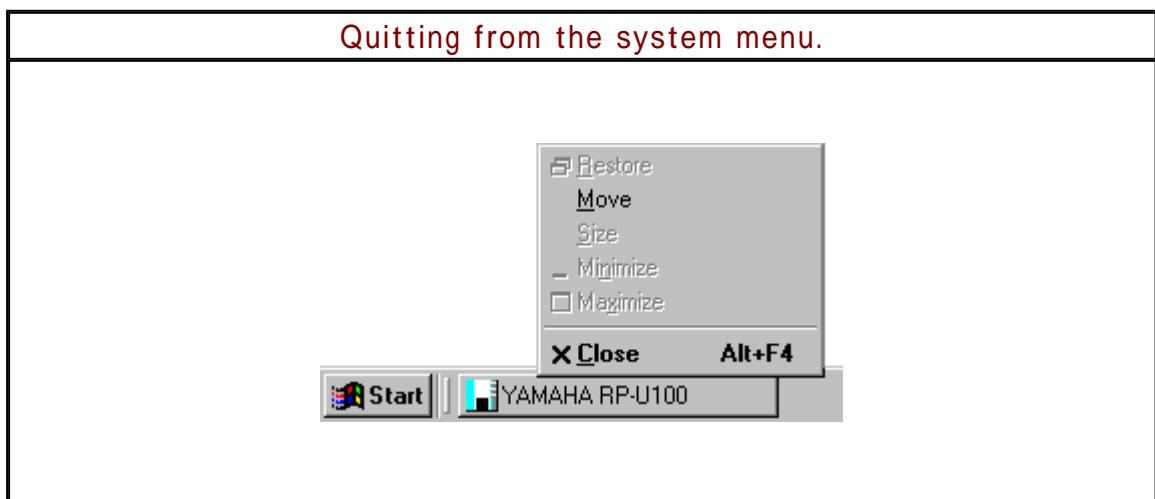

Right-click on the "YAMAHA RP-U100" icon in the task bar and select "X Close" from the system menu.

Starting the Application

Method 1

Open the Windows Start menu and select "YAMAHA RP-U100". The choices "RP-U100" and "Help" appear.

To start the RP-U100 Application, select "RP-U100". To call up the help file, select "Help".

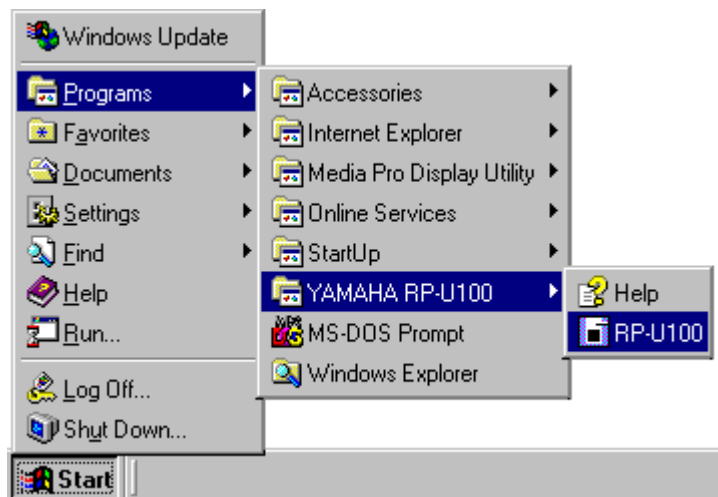

Method 2

If a shortcut icon has been created on the desktop, start the RP-U100 Application by double-clicking the shortcut icon.



Shortcut icon

Method 3

Open the folder where the RP-U100 Application is installed and double-click the RP-U100 icon.



RP-U100 application icon

Glossary

RP-U100 APPLICATION VOCABULARY

Main panel

This is the main panel of the Application. It lets you switch the power on and off, perform basic functions, and call up other panels. Main Panel details

[Main Panel details](#)

Setup Dialog

Lets you make various parameter settings.

[Setup Dialog details](#)

Tuner Panel (frequency display)

Lets you manually select a station on the tuner.

[Tuner Panel \(frequency display\) details](#)

Tuner Panel (preset display)

This panel is for selecting a preset station on the tuner.

[Tuner Panel \(preset display\) details](#)

Preset Edit Panel

This panel serves for storing preset stations.

[Preset Edit panel details.](#)

DSP Sound Field Selector Panel

Lets you select a DSP sound field program and perform related functions.

[DSP Sound Field Selector Panel details](#)

DSP Parameter Setting Panel

Lets you edit various DSP parameters.

[DSP Parameter Setting Panel details](#)

Virtual 3D Parameter Setting Panel

Lets you edit various Virtual 3D parameters.

[Virtual 3D Parameter Setting Panel details](#)

Dynamic Range Setting Panel

Lets you change the dynamic range settings.

[Dynamic Range Setting Panel details](#)

USB Capture

This function uses the USB link to send digital data to the computer for recording. The data are obtained by A/D conversion of analog input signals to the RP-U100.

[USB Capture details](#)

USB MIX LEVEL

This function allows listening to music signals from the computer connected by USB even when AUX1, AUX2, or TUNER IN is selected. The mix level setting determines the ratio of the USB signal to the AUX1, AUX2, or TUNER IN input signal. The setting is made by dragging a slider on the Setup panel.

[USB MIX LEVEL details](#)

SETUP DEVICE NAME

This item lets you specify names that are displayed for audio devices connected to the RP-U100. The setting is made by entering the names in fields on the Setup panel.

[SETUP DEVICE NAME details](#)

MAX VOL. POSITION

This item sets the upper limit for the volume setting that can be made with the Application.

[MAX VOL. POSITION details](#)

RP-U100 TUNER TERMS

Frequency display

Allows you to manually tune to any frequency and to perform scan tuning.

[Tuner Panel \(frequency display\) details](#)

Preset store

Allows you to store a desired station in memory for quick recall.

[Preset Edit Panel details](#)

Preset recall

Allows you to select any of the stored preset stations.

[Tuner Panel \(Preset Recall\) details](#)

Preset page

A "page" is a group of 8 preset stations displayed on a single panel. This lets you organize preset stations for example by music genre. A short title can be specified for each page.

[Preset page details](#)

FM/AM select

This refers to selecting FM Auto Stereo, FM Mono, or AM. Use the FM/AM selector button and the FM mode selector button.

[FM/AM selector details](#)

[FM mode selector details](#)

Manual tuning

Refers to receiving broadcast stations by setting the frequency manually. Use the manual tuning up/down buttons.

[Manual tuning details](#)

Auto tuning (auto scan)

This function automatically scans the current frequency band and stops when a station is found. Use the auto scan up/down buttons.

[Auto tuning \(auto scan\) details](#)

RP-U100 DSP SOUND FIELD TERMS

Sound field

The unique acoustic characteristics of a given space.

In locations such as a concert hall, we of course hear the direct sound coming for example from an instrument. But our ears also pick up the so-called early reflections, which is the sound being reflected from boundaries such as walls, floors and the ceiling. Finally, we hear reverberation, namely the sound being repeatedly bounced back and forth and gradually decaying.

The early reflections and reverberation characteristics depend on factors such as the size and shape of the interior space and the type of furnishing. The resulting acoustics are unique to a particular hall or room. This is what is called a "sound field."

DSP sound field program

Yamaha has collected a vast amount of sound field data at famous concert halls, opera houses, and other venues around the world. These data express the direction of reflections, their intensity, frequency characteristics, delay time, and many other factors.

The RP-U100 incorporates sound field programs based on such sound field data. The programs let you select the sound field of a famous concert hall or theater to be recreated on your personal computer equipment setup.

DSP sound field program icon

There are icons which represent certain DSP sound field effects. A sound field program can be selected by clicking the icon in the DSP sound field selector panel. The icon of the currently selected sound field program is shown on the DSP button in the main panel.

[DSP sound field program icon details](#)

DSP parameters

The default parameter values of the sound field programs are usually fine for enjoying great sound, but it is also possible to fine-tune some of the parameters to suit individual preferences or program sources.

The result will be a listening experience that is truly original and thrilling. Parameters are edited on the DSP Parameter Setting Panel.

[DSP Sound Field Program Parameter guide](#)

[DSP Parameter Setting Panel details](#)

Virtual 3D

Usually four to six speakers are needed to reproduce multichannel sources with Dolby Digital or Dolby Pro Logic. The unique Virtual 3D technology developed by Yamaha produces a convincing surround effect with just two speakers placed left and right in front of the listener. The Virtual 3D setting panel also lets the user adjust 3D parameters.

[Virtual 3D Parameter Setting Panel details](#)

Virtual Rear Speaker Position

This item allows the user to control the position of the virtual (simulated) rear speakers. The setting is done using a graphic image on the DSP Parameter Setting Panel.

[Virtual Rear Speaker Position details](#)

Test Tone

The test tone is used to check the virtual rear speaker position.

[Test Tone details](#)

Balance

This refers to the level balance between the left and right channels. The setting can be changed on the DSP Parameter Setting Panel.

[Balance details](#)

Personal setting [Main, Sub]

This item allows adjusting the 3D sound field effect to the conditions in a given listening room.

In Virtual 3D, the sound field effect will vary according to environment factors such as the listening position and the shape of the room. The virtual rear speaker position may therefore not exactly match the position displayed on the setting screen. The Main and Sub parameters allow the listener to adjust the virtual rear speaker position to the point where the best effect is achieved. Change these parameters as needed to match your personal preferences. The setting can be changed on the DSP Parameter Setting Panel.

[Personal Setting details](#)





 Click !!

Main Panel
(STANDBY mode)



[ON mode](#)

[\[Panel image On\]](#)[\[Panel image Off\]](#)

RP-U100 Main Panel Functions (Standby Mode)

Power Control	Click the Power Control button  to turn on the RP-U100 main unit. Power control details
Minimizing the application	Click the Minimize button  to turn the application into an icon on the task bar. Minimizing details
Quitting the application	Click the Close button  to quit the application. Quitting details

RP-U100 Main Panel

-  If the RP-U100 main unit is on, the Application will also start in the On mode.
-  The error message "[Can't find RP-U100 !!](#)" appears at start up when the main unit and personal computer are not connected with a USB cable.





Main Panel
(ON mode)

[Standby mode](#)

[\[Panel image On\]](#)[\[Panel image Off\]](#)







RP-U100 Main Panel Functions (ON Mode)









 When clicking some items on the main panel, the function will vary according to whether a right click or left click was performed with the mouse.

 The function description in this help file refers to the mouse settings for a right-handed person.

When the mouse is set up for a left-handed person, the button functions will be reversed for left and right. Check the setting in the mouse settings dialog box.

[Windows: mouse settings dialog box.](#)

Power Control	Clicking the Power Control button  will switch the RP-U100 unit alternately between ON and Standby. Power control details
Setup Dialog display	Click the SETUP button  to calls up the SETUP DIALOG. Setup Dialog details
Minimizing the application	Click the Minimize button  to turn the application into an icon on the task bar. Minimizing details
Quitting the application	Click the Close button  to quit the application.. Quitting details
Mode Selection	<div style="text-align: center;">  Input Selector </div> <p>Left click the input selector to switch between PC (personal computer), AUX1, AUX2, TUNER.. Input Selector details</p>
Volume Control	<div style="text-align: center;"> <p>Volume Indicator</p>  </div> <p>Drag the volume indicator dot around the DSP button. Volume Control details</p>
	<div style="text-align: center;">  </div>

<p>DSP Sound Field Effect On/Off switching</p>	 <p>DSP button</p> <p>Clicking the upper part of the DSP Button turns the DSP sound effect on and off.</p> <p>DSP Button details</p>
<p>Graphic Equalizer display</p>	 <p>Clicking the  in the lower part of the DSP button while DSP is OFF brings up the graphic equalizer.</p> <p>Graphic equalizer details</p>
<p>DSP Sound Field Selector Panel display</p>	 <p>Left click the  in the sound field icon to bring up the DSP Sound Field Selector Panel.</p> <p>DSP Sound Field Selector Panel details</p>
<p>DSP Sound Field Selector display</p>	<p>Right clicking the DSP button brings up a list of sound field programs. Select the DSP sound field from them.</p> <p>DSP Sound Field Selector details</p>
<p>Muting</p>	<p>Click the mute button  to turn the speaker output on or off.</p> <p>Mute button details</p>
<p>Tuner Panel display</p>	 <p>To bring up Tuner Panel, click the  shown on the input selector in tuner mode.</p> <p>Tuner Panel details</p>

Input Selector

RP-J100

The input selector is used to select a program source mode such as PC (Personal Computer), AUX1, AUX2, or TUNER.



Input Selector

Mode	Description
PC	This mode serves for playing back an audio signal from the computer. Depending on the PC input type, there are three settings (USB, PC_DIGITAL, PC_ANALOG). Right-click on the PC bar to bring up the PC input type selector.
AUX1	This mode serves for playing back the signal from a component connected to the AUX1 inputs. There are digital (optical) and analog signal input jacks. Automatic switching gives priority to digital signals.
AUX2	This mode serves for playing back the signal from a component connected to the AUX2 inputs. There are only analog signal input jacks.
TUNER	This mode serves for playing back the signal from the built in tuner.

PC (Personal Computer) Mode

RP-U100 PC (Personal Computer) Mode



- When the input selector is set to PC mode, clicking the PC bar repeatedly switches the input signal type as follows:

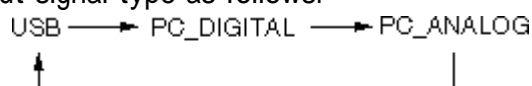

- Right-click on the PC bar to bring up the PC input type selector.

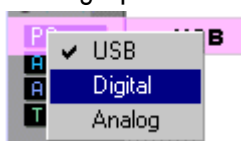

Select the PC input type you want to use

USB	<p>This position serves for playing back a digital audio signal from the computer supplied to the RP-U100 via the USB link.</p> <p>To use this position, the USB cable must be connected between the PC and the RP-U100, and appropriate settings must be made on the computer to output the audio signal.</p> <p>USB connection details</p>
DIGITAL	<p>This position serves for playing back a digital audio signal from the computer supplied to the RP-U100 via the digital input jacks.</p> <p>Both optical and coaxial jacks are provided. The RP-U100 performs automatic switching by hardware, giving priority to the optical input.</p>
ANALOG	<p>This position serves for playing back an analog audio signal from the computer supplied to the RP-U100 via the analog input jacks.</p>

! The USB capture function is not available in PC input mode.

[USB capture details](#)

AUX1 Mode

RP-U100 AUX1 Mode



AUX1 mode

- ☰ This mode serves for playing back the external input signal. There are digital (optical) and analog signal input jacks. Automatic switching gives priority to digital signals.

RP-U100 USB Capture

- ☰ In AUX1 mode, the signal that will be recorded by USB capture is the signal input from the AUX1 - ANALOG input jacks on the main unit. If AUX1 - DIGITAL was selected, the RP-U100 will automatically switch over to AUX1 - ANALOG. Also when the USB MIX LEVEL setting is active, the mixed signal from a computer connected with the USB cable cannot be captured.

[USB capture details](#)

AUX2 Mode

RP-U100 AUX2 Mode



AUX2 mode

- This mode serves for playing back the signal from an external component. There are only analog signal input jacks.

RP-U100 USB Capture

- In AUX2 mode, the signal that will be recorded by USB capture is the signal input from the AUX2 - ANALOG input jacks on the main unit. Also when the USB MIX LEVEL setting is active, the mixed signal from a computer connected with the USB cable cannot be captured.

[USB capture details](#)

TUNER Mode

RP-U100 Tuner Mode



Tuner Mode

- In tuner mode, clicking  on the input selector brings up the Tuner Panel.

RP-U100 Tuning Functions

- The tuner lets you select stations either by manually changing the frequency or by using auto scan. A preset display for calling up stations that have been stored in memory is also available.

Frequency display	<ul style="list-style-type: none"> * Manual tuning * Auto tuning
Preset display	<ul style="list-style-type: none"> * Calling up preset stations * Storing preset stations

RP-U100 USB Capture

- In tuner mode, the signal that will be recorded by USB capture is the signal from the internal tuner.

Also when the USB MIX LEVEL setting is active, the mixed signal from a computer connected with the USB cable cannot be captured.

[USB capture details](#)

Mute Function

RP-U100 Muting On/Off



- The mute function serves to temporarily cut off the sound. It can be turned on or off by clicking the Mute button.

Headphones not connected		Headphones connected	
MUTE OFF	MUTE ON	MUTE OFF	MUTE ON

- The mute function can only be switched on from the application.
 - !** Muting is automatically canceled when the volume is adjusted either on the RP-U100 main unit or with the Application.
- Turning the power on or setting the unit to standby also cancels the mute function.

Power Control

RP-U100 Power On/Standby



- Click the Power button on the main panel to switch the power between ON and STANDBY.

Power	Status
STANDBY	AC power cord is connected and unit power switch or Application power button was set to STANDBY.
ON	AC power cord is connected and unit power switch or Application power button was set to ON.

[Main Panel \(Standby\) details](#)

[Main Panel \(On\) details](#)

RP-U100 Power Off



OFF	AC power cord is disconnected.
-----	--------------------------------

Volume

RP-U100 Volume Control

Volume Indicator



Volume control	
	<ul style="list-style-type: none"> ☰ Drag the volume indicator dot around the circumference of the DSP button.
	<ul style="list-style-type: none"> ☰ When the volume indicator is selected, the green dot becomes red.
	<ul style="list-style-type: none"> ☰ To increase the volume, drag the dot clockwise. To decrease the volume, drag the dot counterclockwise.

- ! Using the Setup Dialog, you can set the upper volume limit for the volume as adjusted with the application. This helps to prevent excessively loud settings made by mistake.
- ! If the volume control on the RP-U100 main unit was used to set the volume to a level higher than the upper limit for the application, the volume will return to the upper limit setting the next time the volume control of the application is used.
- ! Note that the volume may sometimes jump up suddenly when the dot on the application is moved. You should therefore pay attention to the MAX VOLUME POSITION on the setup dialog.

[Setup Dialog details](#)

DSP button

RP-U100 DSP Button

- Click the upper part of the DSP button to turn the DSP sound field program on and off.



- "DSP OFF" appears when the DSP function is off.
The selected sound field icon appears when the DSP function is on.

[Sound field program details](#)

- Right-clicking on the DSP button brings up the sound field selector, regardless of whether the DSP function is on or off.

[DSP Sound Field Selector details](#)

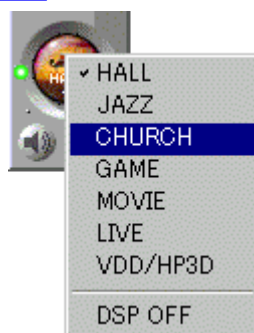





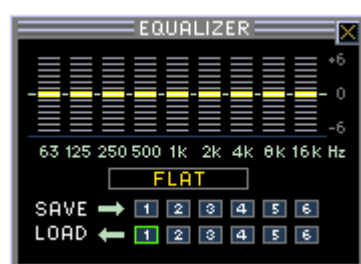



RP-U100 DSP button function during DSP OFF



- Clicking the  in the lower part of the DSP button brings up the graphic equalizer.



Graphic equalizer

 Drag the  of a frequency up and down.
 Clicking  returns all frequencies to flat response.

 A total of six equalizer settings can be stored in the memory with SAVE.
 Saved settings (1-6) can be recalled with LOAD.



 Closing the graphic equalizer

Click the Close Button  or the lower part of the DSP button  to close the graphic equalizer

! When DSP is activated, the graphic equalizer panel closes, but the graphic equalizer shown as part of the DSP sound field parameter edit panel can be used instead.

[DSP Parameter Setting Panel: graphic equalizer details](#)

RP-U100 DSP button function during DSP ON

  Clicking  in the lower part of the sound field icon brings up the DSP sound field selector panel.

[DSP Sound Field Selector Panel details.](#)



SETUP Button

RP-U100 SETUP DIALOG



- Click the Setup button  in the upper left corner of the main panel.

[Setup Dialog details](#)

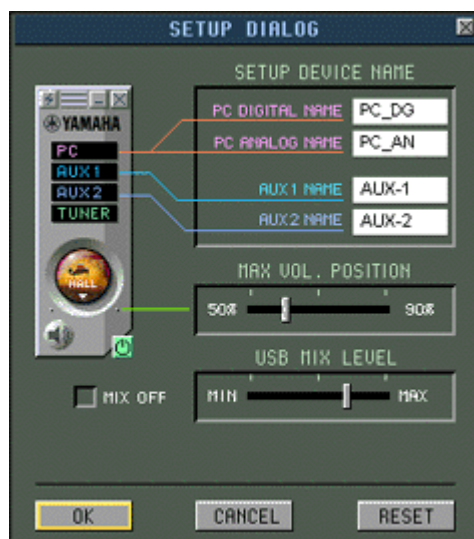

Minimizing the Application

RP-U100 How to Minimize the Application



- Click the Minimize button  on the upper part of the main panel. The application is minimized and displayed in the task bar.

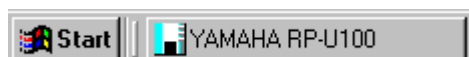

- To return to the original size, click "YAMAHA RP-U100" on the task bar or right-click "Restore" on the system menu.



Error Message at Startup

RP-U100 The error message "Can't find RP-U100 !!" appears when the main unit and personal computer are not connected with a USB cable.



- ! Connect the RP-U100 unit to the computer with a USB cable when using the application.
- ! Even if the RP-U100 unit and computer are connected by a USB cable, the error message will appear if the power cord of the RP-U100 is not plugged into the AC outlet.

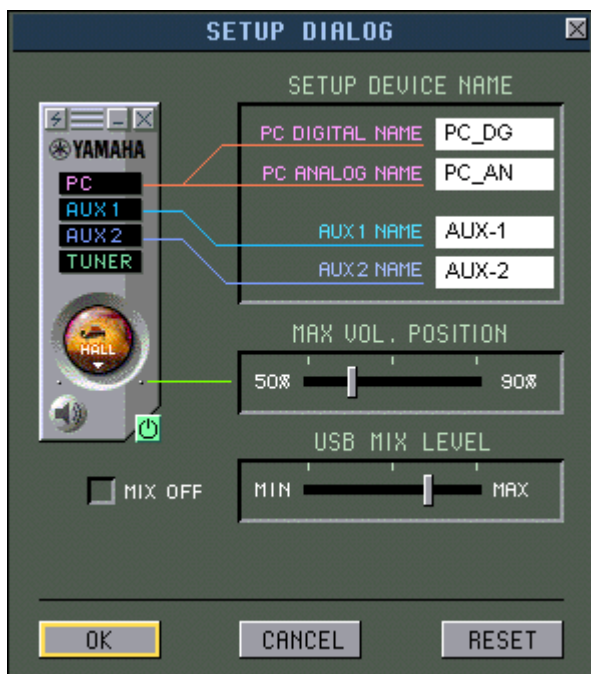

 Click !!

Setup Dialog

[\[Dialog image On\]](#)[\[Dialog image Off\]](#)

RP-U100 Calling Up the Setup Dialog







Click the Setup button  in the upper left corner of the main panel.

RP-U100 SETUP DEVICE NAME

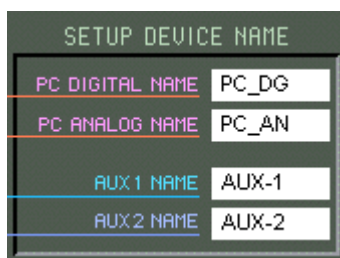
This lets you assign customized names to devices connected to the RP-U100.

! The name can be up to five characters long.



PC DIGITAL NAME	<p>Click the Setup button  This sets the name of the audio device connected to PC-DIGITAL</p> <table border="1" style="width: 100%;"> <tr> <td style="text-align: right;">Input jacks</td> <td>Digital (coaxial and optical)</td> </tr> <tr> <td style="text-align: right;">Priority</td> <td>Optical</td> </tr> </table>	Input jacks	Digital (coaxial and optical)	Priority	Optical
Input jacks	Digital (coaxial and optical)				
Priority	Optical				
PC ANALOG NAME	<p>Click the Setup button  This sets the name of the audio device connected to PC-ANALOG.</p> <table border="1" style="width: 100%;"> <tr> <td style="text-align: right;">Input jacks</td> <td>Analog</td> </tr> </table>	Input jacks	Analog		
Input jacks	Analog				
AUX1 NAME	<p>Click the Setup button  This sets the name of the audio device connected to AUX1.</p> <table border="1" style="width: 100%;"> <tr> <td style="text-align: right;">Input jacks</td> <td>Digital (optical) and analog</td> </tr> <tr> <td style="text-align: right;">Priority</td> <td>Digital</td> </tr> </table>	Input jacks	Digital (optical) and analog	Priority	Digital
Input jacks	Digital (optical) and analog				
Priority	Digital				
AUX2 NAME	<p>Click the Setup button  This sets the name of the audio device connected to AUX2.</p> <table border="1" style="width: 100%;"> <tr> <td style="text-align: right;">Input jacks</td> <td>Analog</td> </tr> </table>	Input jacks	Analog		
Input jacks	Analog				

RP-U100 Setting the USB Mix Level

- ☰ Audio signals from the computer supplied via USB cable can be mixed and reproduced by the RP-U100 even when an input other than USB is selected.

MIX OFF



☰ Audio signals from the computer connected via USB cable will not be heard while input sources other than USB are selected.

MIX OFF

☰ Audio signals from the computer connected via USB cable will be mixed with input sources other than USB.

! DSP sound field programs affect only the sound from input sources other than USB, not the audio signals from the computer.



☰ Drag the  slider towards MAX to increase the mix ratio of audio signals from the computer connected by USB. Dragging the slider towards MIN decreases the ratio of audio signals from the computer. (A  appears at the default setting.)

! Changing the mix ratio does not affect the level of source other than USB.

RP-U100 Setting the Max Volume Position

- ☰ This determines the upper volume limit that can be set with the application.



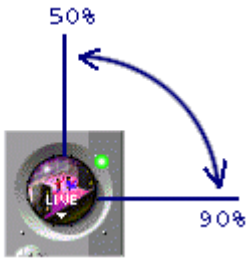



☰ The setting can be between 50 and 90% on the volume indicator.



☰ Drag the  slider left or right.

Drag the  slider left or right.

(A  appears at the default setting [50%])

 Note that the volume may sometimes jump up suddenly when the dot on the application is moved. You should therefore use caution when setting the MAX VOL. POSITION.

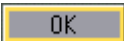
OK, CANCEL, RESET Buttons

	Saves all changes and closes the Setup Dialog.
	Aborts all changes and closes the Setup Dialog.
	Resets all items to the factory defaults.

Closing the Setup Dialog

 Click the Close button  to close the Setup Dialog.

 If changes were made, be sure to save them by clicking OK before clicking the Close button.

DSP Sound Field Program

RP-U100 DSP Sound Field Programs

The unique acoustic characteristics of a given space.

In locations such as a concert hall, we of course hear the direct sound coming for example from an instrument. But our ears also pick up the so-called early reflections, which is the sound being reflected from boundaries such as walls, floors and the ceiling. Finally, we hear reverberation, namely the sound being repeatedly bounced back and forth and gradually decaying.

The early reflections and reverberation characteristics depend on factors such as the size and shape of the interior space and the type of furnishing. The resulting acoustics are unique to a particular hall or room. This is what is called a "sound field."

Yamaha has collected a vast amount of sound field data at famous concert halls, opera houses, and other venues around the world. These data include the direction of reflections, their intensity, frequency characteristics, delay time, and many other factors.

The RP-U100 incorporates sound field programs based on such sound field data. The programs let you select the sound field of a famous concert hall or theater to be recreated on your personal computer equipment setup.

RP-U100 DSP sound field programs for music

The DSP programs for music create a sound field giving the realistic impression of being in a specific location. The original signal is passed unchanged to the output, while sound field information is added by means of DSP processing. Also with multichannel source material encoded in Dolby Digital, the decoded signal is reproduced unchanged with only the ambience components added. This allows you to enjoy the sound of a world-famous concert hall, church, or other type of location.

RP-U100 DSP sound field programs for Audio Visual

These DSP programs were specially developed for game or movie sound reproduction. The action of surround decoders for Dolby Pro Logic and Dolby Digital is fused with the Yamaha DSP, resulting in quality sound such as would be heard in the final mix of a completed movie. The RP-U100 lets you reproduce this sound in your own personal space.





 Click !!

DSP Sound Field Selector Panel



[\[Panel image On\]](#)[\[Panel image Off\]](#)

RP-U100 Calling up the DSP Sound Field Selector Panel

-  Clicking the  on the lower part of the sound field icon on the main panel brings up the DSP Sound Field Selector Panel.

[DSP button details](#)

RP-U100 DSP Sound Field Program icons

-  There are eight icons with images of DSP sound fields.
HALL JAZZ CHURCH GAME MOVIE LIVE VDD (HP3D)
-  HP3D is displayed instead of VDD when headphones are used.





Sound field icons

Sound field programs for music	 HALL	 JAZZ	 CHURCH
Sound field programs for Audio Visual	 GAME	 MOVIE	 LIVE
Virtual 3D	 VDD	 HP3D	

RP-U100 Select the applicable DSP sound field program



- ☰ Four DSP sound field icons are displayed at one time on the panel.
- ☰ Other icons can be viewed by clicking  to scroll the screen.
- ☰ Clicking an icon selects the sound field for that icon.



Icon for selected program is displayed

- ☰ The sound field program can also be selected directly from the main panel.

[DSP Sound Field Selector details](#)

[Main Panel details](#)

RP-U100 Calling Up the DSP Parameter Setting Panel



- ☰ Clicking EDIT brings up the DSP parameter setting panel.

[DSP Parameter Setting Panel details](#)

RP-U100 Calling Up the Virtual 3D Parameter Setting Panel



- ☰ Clicking **VIRTUAL** brings up the Virtual 3D Parameter Setting Panel.

[Virtual 3D Parameter Setting Panel details](#)

RP-U100 Calling up the Dynamic Range Setting Panel



- ☰ Clicking **D-RANGE** brings up the Dynamic Range Setting Panel.

[Dynamic Range Setting Panel details](#)

RP-U100 Closing a Panel.

 Click the Close button  to close a panel.

DSP Sound Field Selector



DSP button



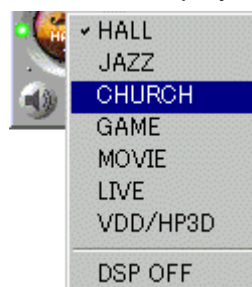



 Right-click on the DSP ON/OFF button to display the sound field selector.





☰ Clicking on a sound field name switches the DSP sound field program.

Introduction to Sound Field Programs

 HALL	<p>This is the sound field of a 'shoebox' type medium-sized hall in Vienna seating about 1700 people. This sound field has beautiful, rich acoustics that faithfully reproduce the complicated reverberations from the surrounding pillars and carvings in the hall.</p>
 JAZZ	<p>This program recreates the acoustics of a small venue for live on-stage productions in New York. The sound field is for an area somewhat left of center facing the stage.</p>
 CHURCH	<p>This is the sound field of a beautiful gothic type monastery in a Paris suburb. The reverberations blend in the numerous domed ceiling spaces formed by stone pillars, producing beautiful sustained notes.</p>
 GAME	<p>This program adds a feeling of depth and ambience to game sounds. Allows enjoying the pressure and excitement of a game as if actually there.</p>
 MOVIE	<p>This sound field recreates the sensation of an expansive space that makes you feel like you are in the midst of a movie.</p>
 LIVE	<p>This sound field reproduces the high-energized sensation of live rock and jazz music.</p>
 VDD	<p>This program (Virtual Dolby Digital) approximates the surround sound effect of Dolby Digital using only two front-channel speakers. Ideal for faithful reproduction of DVD software encoded in the Dolby Digital format.</p>



HP3D

This program (Headphone 3D) simulates multi-speaker surround sound when listening with headphones. It is automatically activated instead of VDD mode when headphones are plugged into the RP-U100.

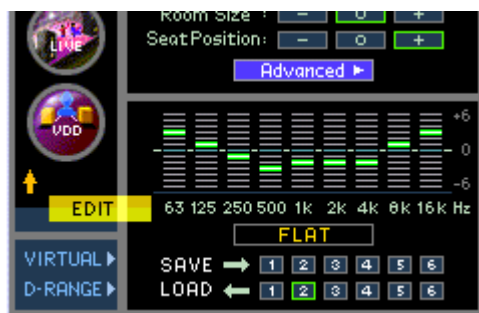



DSP Parameter Setting Panel

[\[Panel image On\]](#)[\[Panel image Off\]](#)

RP-U100 Calling up the DSP Parameter Setting Panel



☰ Click EDIT on the DSP Sound Field Selector Panel.

! The DSP Sound Field Selector Panel must be visible.



To display the DSP Sound Field Selector Panel, click  in the lower part of the sound field icon on the main panel.

[DSP button details](#)

RP-U100 DSP Parameters

- ☰ The default parameter values of the sound field programs are usually fine for enjoying great sound, but it is also possible to fine-tune some of the parameters to suit individual preferences or program sources.
- ☰ The result will be a listening experience that is truly original and thrilling.

DSP Parameters	
Parameter	FUNCTION
Effect Trim	Makes fine adjustments to the effect level (sound effect).
Rear Effect Trim	Makes fine adjustments to the rear effect level (sound effect).
Initial Delay	Adjusts the sensation of distance between walls and sound source.
Room Size	Adjusts the sense of expansiveness.
Liveness	Adjusts the apparent reflectivity of the walls.
S. Delay (Surround Delay)	Adjusts the delay time of the surround sound field.
S.Initial Delay (Surround Initial Delay)	Adjusts the initial delay time of the surround sound field.
S.Room Size (Surround Room Size)	Adjusts the room size of the surround sound field.
Reverb Time	Adjusts the duration of the reverberation.
Reverb Level	Adjusts the intensity of the reverberation.
Reverb Delay	Adjusts the delay time of the reverberation.

[Reverb Delay](#)

Adjusts the delay time of the reverberation.

RP-U100 Changing DSP parameters**Basic parameter settings**

Effect Level	Makes fine adjustments to the effect level (sound effect).
Room Size	Adjusts the sense of expansiveness.
Seat Position	Adjusts the simulated seat position.

**Basic parameter setting screen**

Click on **-**, **○**, or **+** to make the selection. The selected button changes to green.

Detailed parameter settings

- Besides the basic parameters, more parameters can be adjusted on the advanced parameter setting screen

Click **Advanced** to go to the Advanced parameter setting screen.

Click **Basic** to return to the Basic parameter setting screen.

- Each sound field program has some parameters that can be changed.

Advanced parameter details

- In order to change a parameter, click **◀ ▶** or directly slide the pointer **●** to the desired position.
- Click **Default** to return to the default values.

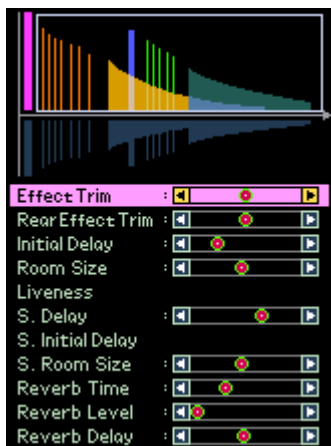
**Advanced parameter setting screen**

Advanced parameter setting screen

Effect Trim : 



Selected parameter

! The parameters shown on the display vary according to the sound field program.

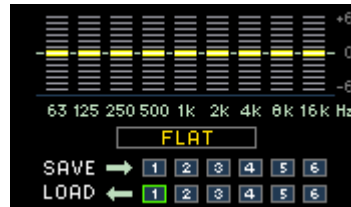
RP-U100 Setting the Graphic Equalizer



 Drag the  of a frequency up and down.

 Click  to return all frequencies to flat response.



 A total of six equalizer settings can be stored in the memory with SAVE.

 Saved settings (1-6) can be recalled with LOAD.

RP-U100 Closing the Panel.

 Click the EDIT button or click the Close button  to close the panel.

EP-U100 Field Program Parameter Guide

Effect Trim

Can be set for HALL JAZZ CHURCH GAME MOVIE LIVE

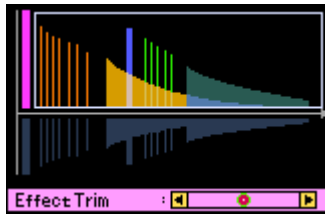

Effect Trim Setting Screen

Function: ?Makes fine adjustments to the effect level (sound effect).
 Variable range: -3 dB to +3 dB
 Description: This is a parameter for making fine adjustments to the overall effect sound level.

Rear Effect Trim

Can be set for HALL JAZZ CHURCH GAME MOVIE LIVE VDD (HP3D)

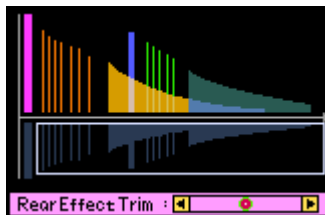

Rear Effect Trim Setting Screen

Function: Makes fine adjustments to the rear effect level (sound effect).
 Variable range: -3 dB to +3 dB
 Description: This is a parameter for making fine adjustments to the overall rear effect sound level including the Virtual 3D sound effect.

Initial Delay

Can be set for HALL JAZZ CHURCH GAME MOVIE LIVE

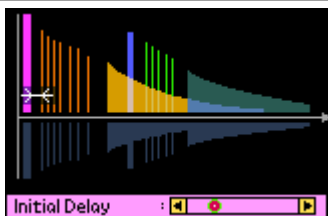

Initial Delay Setting Screen

Function: Adjusts the sensation of distance between walls and sound source.

Variable range: 1 ms to 99 ms

Description: This is a parameter for controlling the delay between the direct sound and the start of the early reflection. The delay in the early refraction is determined by the distance between the walls and sound source. In other words, shortening the delay time gives the impression that the sound source is near the walls. Conversely, lengthening the delay time gives the impression that the sound source is far from the walls.

Adjusting the Initial Delay allows controlling factors such as the sense of distance from the source of the sound to the surrounding walls, the sensation of spatial size, and the nature of the tone (or sound image).

Room Size

Can be set for HALL JAZZ GAME MOVIE LIVE

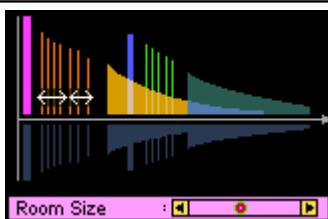

Room Size Setting Screen

Function: Adjusts the sense of expansiveness.

Variable range: 0.1 to 2.0

Description: This parameter controls the sense of spatial expansiveness.

The larger the value, the wider the perceived space. When there is a larger distance between the walls of a room, the number of reflections increases and the time interval between reflections becomes longer. Therefore, controlling the time between adjacent reflections makes it possible to change the impression of spaciousness.

A parameter setting of 1.0 means that the original measured values are used. At a setting of 2.0, the simulated length of one room boundary is doubled.

Liveness

Can be set for HALL JAZZ

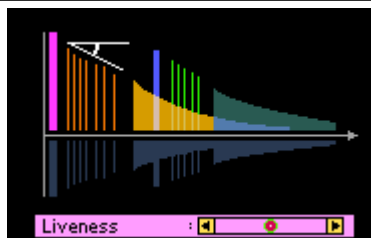

Liveness Setting Screen

Function: Adjusts the apparent reflectivity of the walls.

Variable range: 0 to 10

Description: This parameter determines the attenuation of the early reflections. The larger this value, the greater the sound field echo. The smaller this value, the weaker the echo, giving a "dead" impression. This live or dead sensation for an actual hall is determined by the absorption characteristics of the reflecting surfaces. Faster attenuation of reverberations results in a more "dead" character and slow attenuation in a more "live" character.

more "dead" character and slow attenuation in a more "live" character.

S. Delay (Surround Delay)

During Dolby Digital input	Can be set for HALL JAZZ CHURCH GAME MOVIE LIVE VDD (HP3D)
During Dolby Pro Logic	Can be set for GAME MOVIE LIVE VDD (HP3D)

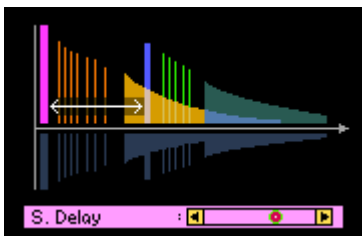

S. Delay Setting Screen

Function: Adjusts the delay time of the surround sound field.
 Variable range: 0 ms to 15 ms with Dolby Digital.
 15 ms to 30 ms with Dolby Pro Logic.

Description:

With Dolby Digital source
The parameter controls the delay time between the direct sound and the surround sound source. The greater this value, the greater the delay occurring in the surround sound field.
With Dolby Pro Logic
The parameter controls the delay time between the direct sound and the surround sound field. The greater this value, the greater the delay occurring in the surround sound field. There is no surround sound source.

S.Initial Delay (Surround Initial Delay)

With Dolby Digital source	Can be set for GAME MOVIE LIVE
---------------------------	--------------------------------

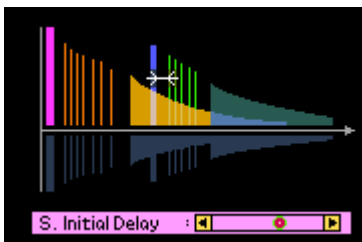

Function: Adjusts the initial delay time of the surround sound field.
 Variable range: 1 ms to 49 ms
 Description: The parameter is enabled when a Dolby Digital source signal is input.
 This parameter controls the initial delay time between the direct sound and the surround sound source.
 The greater this value, the greater the delay occurring in the surround sound field.

S.Room Size (Surround Room Size)

Can be set for GAME MOVIE LIVE

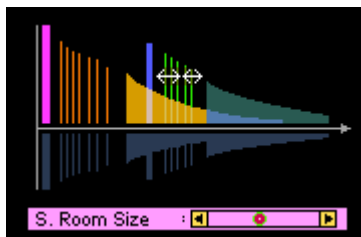

S. Room Size Setting Screen

Function: Adjusts the room size of the surround sound field.
 Variable range: 0.1 to 2.0
 Description: This parameter controls the sensation of expansiveness of the surround sound field. The greater this value, the wider the impression of surround sound field space.

Reverb Time

Can be set for CHURCH GAME LIVE

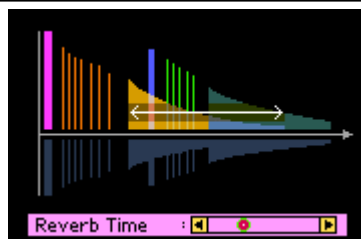

Reverb Time Setting Screen

Function: Adjusts the duration of the reverberation.
 Variable range: ?1.0 sec to 5.0 sec
 Description: This parameter controls the time span in which the reverberation attenuates. This is based on the time required for the reverberation sound to attenuate at a frequency of approximately 1 kHz. The smaller this figure, the faster the attenuation of the reverberation sound. Adjusting this parameter lets you make a dead-sounding source or listening room appear more lively. Conversely, you may want reduce an excessively bright feeling to achieve natural sounding reverberation.

Reverb Level

Can be set for CHURCH GAME LIVE

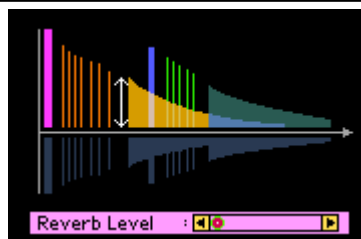

Reverb Level Setting Screen

Function: Adjusts the intensity of the reverberation.
 Variable range: 0 % to 100 %
 Description: This is a parameter for controlling the level of the reverberation sound. The larger this value, the more pronounced will be the reverberation, giving a lingering quality to the sound. Smaller values will reduce reverberation and reduce trailing notes.

Reverb Delay

Can be set for CHURCH GAME LIVE

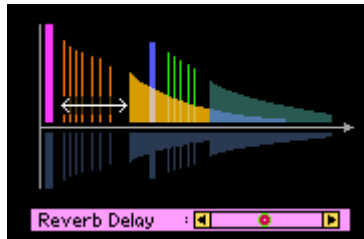

Reverb Time Setting Screen

Function	Adjusts the delay time of the reverberation.
Variable range	0 ms to 250 ms
Description	This parameter controls the time lag until reverberation is produced. The greater this value, the more the delay occurring in the reverberation after the early reflection. Even with the same Reverb Time setting, choosing a higher Delay Time value will result in a larger perceived space with more intense reverberation.



 Click !!



Virtual 3D Parameter Setting Panel

[\[Panel image On\]](#)[\[Panel image Off\]](#)

RP-U100 Calling Up the Virtual 3D Parameter Setting Panel



 Click **VIRTUAL** on the DSP Sound Field Selector Panel.

 To display the DSP sound field selector panel, click  in the lower part of the sound field icon on the main panel.

[DSP button details](#)

RP-U100 Virtual 3D Parameters

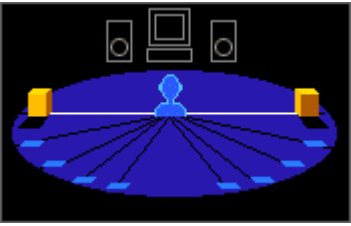
Virtual 3D parameter	
Virtual Rear Speaker Position	<p style="text-align: center;">Sets the position of the virtual rear speakers.</p> 
Personal Setting Main & Sub	<ul style="list-style-type: none"> ☰ In Virtual 3D, the sound field effect will vary according to environment factors such as the listening position and the shape of the room. ☰ The virtual rear speaker position may therefore not exactly match the position displayed on the setting screen. ☰ The Main and Sub parameters allow the listener to adjust the virtual rear speaker position to the point where the best effect is achieved. Change this parameters as needed to match your personal preferences.
Balance	Sets the level balance for the left and right speakers.

Other	
Listening Position	<ul style="list-style-type: none"> ☰ The listening position refers to the spot where the listener actually sits and listens to the sound. ☰ This is not a parameter set on the RP-U100, but the actual position has a considerable influence on the Virtual 3D effect.

RP-U100 [Setting the Virtual Rear Speaker Position](#)

☰ To set the virtual rear speaker positions, click the  squares shown in the figure below or directly drag the virtual rear speaker and move it to the desired position.

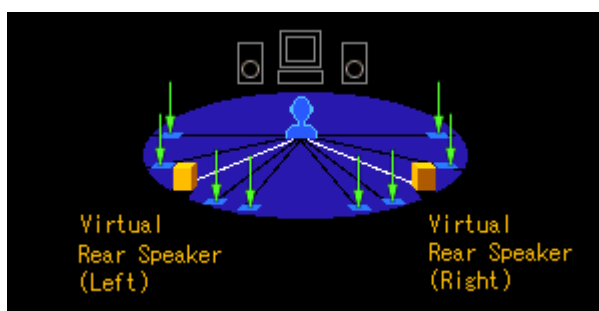

 The virtual rear speakers are set symmetrically left and right.

RP-U100 [Balance Setting](#)

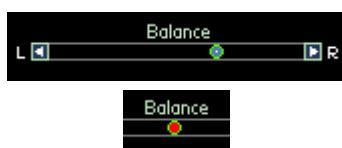

Center Position Display

☰ Adjust the balance by dragging the pointer  or clicking the L(left)/R(right) arrows.

- ! Even if the balance is set fully to left or right, the sound from the opposite side will not be completely cut off.

?

RP-U100 [Personal Setting \(Main & Sub\)](#)

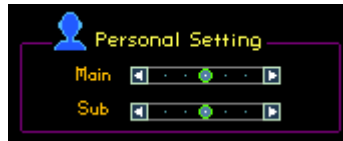

- Adjust the Personal Setting by dragging the pointer or clicking the left/right arrows.

RP-U100 [Test Tone](#)

- The test tone moves automatically through the available virtual speaker positions.

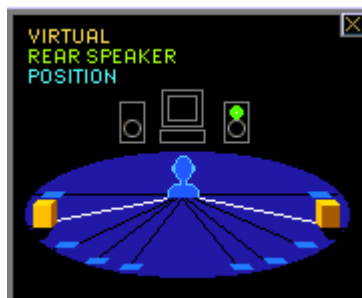

<p>TEST TONE START</p>	<ul style="list-style-type: none"> Clicking START produces a test tone at the current position set for the virtual rear speakers. The test tone moves automatically through the available virtual speaker positions.
<p>TEST TONE STOP</p>	<ul style="list-style-type: none"> Click STOP to turn off the test tone.

RP-U100 [Closing the Panel](#)

- Click VIRTUAL or click ✕ to close the panel.
-

Dynamic Range Setting Panel

RP-U100 Calling Up the Dynamic Range Setting Panel



- Click **D-RANGE** on the DSP Sound Field Selector Panel.
[DSP Sound Field Selector Panel details](#)

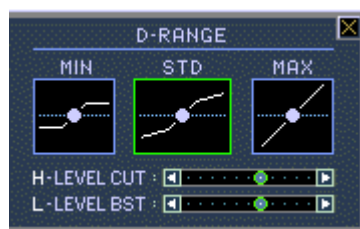

RP-U100 D-RANGE (Dynamic Range)



 Click !!

D-RANGE (Dynamic Range) Setting Panel

- !** Allows you to set 3 types of dynamic range (MAX, STD or MIN) for Dolby Digital playback.

<p>MAX</p>	<p>Unchanged dynamic range of a movie theater</p> 
<p>STD (STANDARD)</p>	<p>The default dynamic range setting is the same as MAX. You can adjust high-level cut (H-LEVEL CUT) and low level boost (L-LEVEL-BST), and set the dynamic range to any desired point between MAX and MIN.</p>  <div data-bbox="400 624 1412 696" style="border: 1px solid black; padding: 5px; margin: 10px 0;"> <p>H-LEVEL CUT : ◀ ▶ L-LEVEL BST : ◀ ▶</p> </div> <p>Click ◀ ▶ or drag the ▶ left or right to adjust the H.-LEVEL.CUT and low level boost L.-LEVEL BST.</p>
<p>MIN</p>	<p>Dynamic range specially tailored for late night viewing/listening. Improves clarity at low volume levels.</p> 

RP-U100 Closing the Panel

☰ Click the Close button ✕ or click **D-RANGE ▶** to close the panel.





Click !!

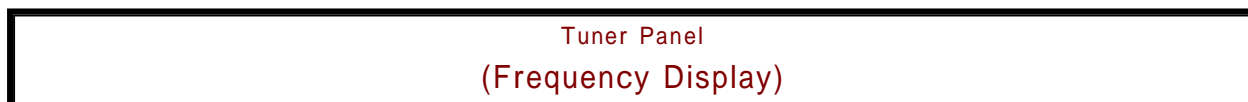

[\[Panel image On\]](#)[\[Panel image Off\]](#)

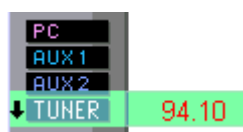

RP-U100 Calling Up the Tuner Panel

















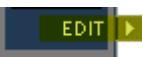

Tuner mode

- Selecting tuner mode in the input selector on the main panel and clicking brings up the frequency display panel.

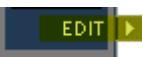
RP-U100 Tuner Panel (frequency display) functions

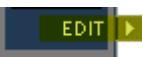
Panel Component	Function
<p>FM/AM selector button</p> 	<ul style="list-style-type: none"> Click on FM or AM to select the respective frequency band. Select FM Auto Stereo or FM Mono with the FM mode selector button.
<p>Auto scan buttons</p> 	<ul style="list-style-type: none"> This function automatically scans the frequency band for stations. Auto scan may not be able to tune in a station if its signal is weak. <p style="text-align: center;">Auto scan function</p> <p>Clicking the Scan button starts the station search. The search ends when a station is found. Click the Scan button again if the scan stops during the search. Search stops also when the auto-scan button is clicked during search. To restart search, click the auto-scan button. If no station is found, the search stops at the frequency where the search began.</p>
<p>Manual tuning buttons</p> 	<ul style="list-style-type: none"> This button lets you tune to a station manually. <div style="border: 1px solid black; padding: 5px; text-align: center;"> <p>Manual tuning operation</p> </div> <p>The frequency increases or decreases by one step each time or is clicked. Keeping a button clicked causes the frequency to change continuously.</p>

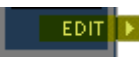
	<p>When the bottom end of the frequency band is reached, the frequency jumps to the top, and vice versa.</p>												
<p>Frequency band display</p> 	<ul style="list-style-type: none"> Shows the frequency range.  Points to the frequency currently being received. The bar moves up and down during manual tuning and auto scan to indicate the frequency.  Displays the figures for the frequency being received. <table border="1"> <thead> <tr> <th colspan="3">Reception Frequency</th> </tr> <tr> <th>?</th> <th>Frequency range</th> <th>Tuning step</th> </tr> </thead> <tbody> <tr> <td>AM</td> <td>530 - 1710 kHz</td> <td>10 kHz</td> </tr> <tr> <td>FM</td> <td>87.5 - 107.9 MHz</td> <td>0.2 MHz</td> </tr> </tbody> </table>	Reception Frequency			?	Frequency range	Tuning step	AM	530 - 1710 kHz	10 kHz	FM	87.5 - 107.9 MHz	0.2 MHz
Reception Frequency													
?	Frequency range	Tuning step											
AM	530 - 1710 kHz	10 kHz											
FM	87.5 - 107.9 MHz	0.2 MHz											
<p>Reception Frequency display</p> 	<ul style="list-style-type: none"> Shows the received frequency in numeric format. 												
<p>Preset page call button</p> 	<ul style="list-style-type: none"> Click   to call up the preset page display. On the RP-U100 main unit, 5 preset pages from A to E can be stored. Using the application, a total of 26 preset pages from A to Z can be stored. Each preset page contains up to 8 stations. <p>Preset Page details</p>												
<p>FM mode selector button</p> 	<ul style="list-style-type: none"> Click the FM mode selector button  to select FM (Auto Stereo) or FM (Monaural). <table border="1"> <thead> <tr> <th>FM mode selection items</th> <th>Functions</th> </tr> </thead> <tbody> <tr> <td> <p>FM Auto Stereo</p>  </td> <td> <p>Tuner automatically receives in stereo when tuned to a stereo broadcast station.</p> <p> If the signal is weak, the tuner may sometimes switch to MONO (monaural reception).</p> </td> </tr> <tr> <td> <p>FM Mono</p>  </td> <td> <p>Tuner receives all FM broadcasts in monaural.</p> </td> </tr> </tbody> </table>	FM mode selection items	Functions	<p>FM Auto Stereo</p> 	<p>Tuner automatically receives in stereo when tuned to a stereo broadcast station.</p> <p> If the signal is weak, the tuner may sometimes switch to MONO (monaural reception).</p>	<p>FM Mono</p> 	<p>Tuner receives all FM broadcasts in monaural.</p>						
FM mode selection items	Functions												
<p>FM Auto Stereo</p> 	<p>Tuner automatically receives in stereo when tuned to a stereo broadcast station.</p> <p> If the signal is weak, the tuner may sometimes switch to MONO (monaural reception).</p>												
<p>FM Mono</p> 	<p>Tuner receives all FM broadcasts in monaural.</p>												
<p>Tuner edit panel display button</p> 	<ul style="list-style-type: none"> Clicking the EDIT button calls up the preset edit panel. <p>Preset Edit Panel details</p>												

RP-U100 Closing the Panel

- Click the Close Button  to close the panel.



 Click !!

Tuner Panel (Preset Display)



[\[Panel image On\]](#)[\[Panel image Off\]](#)

RP-U100 Calling Up the Tuner Panel (Preset display)

-  Click   of  on the Tuner Panel (frequency display).

[Tuner Panel \(frequency display\) details](#)

RP-U100 Preset Page

-  The preset page lets you easily call up a broadcast station that has been stored.
-  The preset page carries a page identifier and page title.

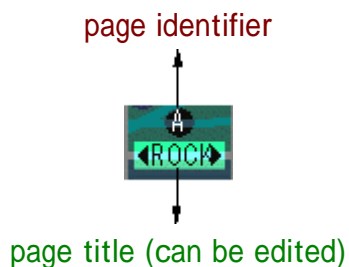

-  On the RP-U100 main unit, 5 preset pages from A to E can be stored. Using the Application, a total of 26 preset pages from A to Z can be stored. Each preset page contains up to 8 stations.

☰ Page identifiers (A-E) appear on the RP-U100 unit display when the selected preset page is A-E. When the page is F-Z, the frequency selected by the user on that page is shown.





[Preset Edit Panel details](#)

☰ Click to change the page.

*** Frequency display A B ***

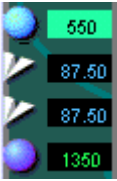
! Pages in the range from F-Z where no station (frequency) is stored will not be displayed.

RP-U100 Panel functions

Panel Component	Function										
<p>Displays the preset stations</p> 	<p>☰ Display of stored frequencies.</p> <table border="1" data-bbox="635 817 1230 922"> <tr> <td></td> <td></td> </tr> <tr> <td>AM icon</td> <td>FM icon</td> </tr> </table> <p>☰ Click the AM or FM icon or the frequency field to select the station.</p> <table border="1" data-bbox="644 1019 1220 1182"> <tr> <td colspan="2">Selected frequency display</td> </tr> <tr> <td>AM</td> <td>FM</td> </tr> <tr> <td></td> <td></td> </tr> </table> <p>☰ 8 stations can be stored on one page.</p> <p>Preset Edit Panel details</p>			AM icon	FM icon	Selected frequency display		AM	FM		
AM icon	FM icon										
Selected frequency display											
AM	FM										
<p>Preset page identifier</p> 	<p>☰ Identifies the page.</p> <p>☰ On the RP-U100 unit, 5 pages from A to E can be stored. On the RP-U100 application, a total of 26 pages from A to Z can be stored.</p>										
<p>Preset page title</p> 	<p>☰ Descriptive title of the page.</p> <p>☰ The page title can be edited as needed.</p> <p>Preset Edit Panel details</p> <p>☰ Clicking moves through the preset pages.</p>										
<p>FM Mode Display</p> 	<p>☰ Display FM reception</p> <table border="1" data-bbox="517 1706 1412 2011"> <tr> <td data-bbox="517 1706 751 1951"> <p>FM Auto Stereo</p> </td> <td data-bbox="751 1706 1412 1951"> <p> Tuner automatically receives in stereo when tuned to a stereo broadcast station.</p> <p> If the signal is weak, tuner may sometimes switch to MONO (monaural reception).</p> </td> </tr> <tr> <td data-bbox="517 1951 751 2011"> <p>FM Mono</p> </td> <td data-bbox="751 1951 1412 2011"> <p> The station is stored in FM Mono.</p> </td> </tr> </table>	<p>FM Auto Stereo</p>	<p> Tuner automatically receives in stereo when tuned to a stereo broadcast station.</p> <p> If the signal is weak, tuner may sometimes switch to MONO (monaural reception).</p>	<p>FM Mono</p>	<p> The station is stored in FM Mono.</p>						
<p>FM Auto Stereo</p>	<p> Tuner automatically receives in stereo when tuned to a stereo broadcast station.</p> <p> If the signal is weak, tuner may sometimes switch to MONO (monaural reception).</p>										
<p>FM Mono</p>	<p> The station is stored in FM Mono.</p>										
<p>Tuner edit panel display button</p>	<p>☰ Click the EDIT button to call up the preset edit panel</p>										

display button



Click the EDIT button to call up the preset edit panel.

RP-U100 Closing the Panel

Click the Close button  to close the panel.



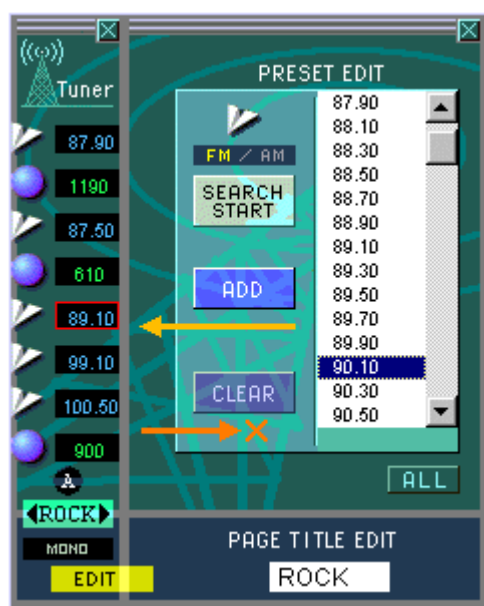

 Click !!

Preset Edit Panel

[\[Panel image On\]](#)[\[Panel image Off\]](#)

RP-U100 Calling Up the Preset Edit panel

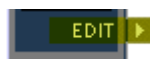

- Click the EDIT button on the Tuner Panel.

[Tuner Panel \(frequency display\) details.](#)





[Tuner Panel \(preset\) details.](#)

- !** Clicking the EDIT button in frequency display mode displays the preset page next to the edit panel.

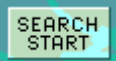

RP-U100 Storing Preset Station

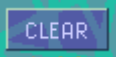
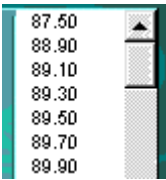
- You create a preset station by storing its frequency on a preset page.
- On the RP-U100 main unit, 5 preset pages from A to E can be stored. Using the application, a total of 26 preset pages from A to Z can be stored.
- Each preset page contains up to 8 stations.
- Page identifiers (A-E) appear on the RP-U100 unit display when the selected preset page is A-E. When the page is F-Z, the frequency selected by the user on that page is shown.

RP-U100 Preset Edit Panel functions

Panel Component	Function
<p>FM/AM selector button</p> 	<ul style="list-style-type: none"> Click FM or AM to select the band to search.
<p>Auto frequency Search</p> 	<ul style="list-style-type: none"> Clicking the SEARCH START button initiates an automatic search of the frequency band. Click the SEARCH STOP button again to stop searching. Auto search may not be able to tune in a station if the signal is weak.
<p>Adding a station</p> 	<ul style="list-style-type: none"> After selecting the frequency you want to store and location on the page, click ADD to store the frequency on that page. <p>Frequency store details</p>
<p>Deleting a station</p> 	<ul style="list-style-type: none"> Select the frequency you want to delete from the preset page (F-Z) and click the CLEAR button. The entry for that frequency is deleted. Stored stations (frequencies) can be deleted only from pages F-Z, not from pages A-E. <p>Frequency delete details</p>
<p>Displaying auto frequency search results</p> 	<ul style="list-style-type: none"> Displays frequencies where stations were found with auto search. Results are displayed in order of frequency from lowest to highest.
<p>All frequency display</p> 	<ul style="list-style-type: none"> Click the ALL button. Displays all reception frequencies.
<p>Page title entry</p> 	<ul style="list-style-type: none"> Enter the title of the preset page. The title can be up to 4 characters long.

RP-U100 Frequency Store

- Click   on the preset page to display the page for storing a frequency.
- Click the frequency you want to store on the page and click the desired location.

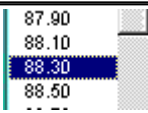
	
Choosing the location	Choosing the Frequency

- To store an FM station, also select the FM mode (Auto Stereo or FM Mono) you want to store. Click the FM Mode selector button **STEREO** and select the mode.

STEREO FM Auto Stereo	Tuner receives FM broadcasts in stereo, but automatically switches to mono if excessive noise is heard in stereo, store the station in FM Mono.
MONO FM Mono	Tuner receives FM broadcasts in mono. If tuner received too much noise in stereo reception, store the station in FM Mono.

- Check that the ADD button is active and click it.

	
Not Active	Active

- Up to 8 stations can be stored on each page.



RP-U100 Deleting a Stored Frequency (on pages F-Z only)

- Click the frequency you want to delete from the preset page.



Frequency to be deleted

- Check that the Clear button is active and click it.

	
Not active	Active

RP-U100 Closing the Preset Edit Panel



- Click the EDIT button or  to close the panel.

Troubleshooting

[Problems with Application]

Don't know how to start application	Refer to startup details page.
Application doesn't start up	Application won't start unless USB link is established between the RP-U100 and PC. Check that the USB cable is connected properly. How to make the USB connection
	Even if the computer and RP-U100 are connected by USB cable, the Application will not start unless the power cord of the RP-U100 is plugged into an AC outlet. Check that the power cord is properly connected.
Don't know how to quit application.	Refer to quitting details page.
Don't know how to operate application	Operation steps are described in this help file. Check "Page Contents" or search for the page by using the "Index, Keyword Search, and Search" tab. Using Help
Don't know how to uninstall.	Refer to uninstall details

[Problems with sound]

No sound	No sound will be heard if the RP-U100 unit is set to STANDBY (OFF). Turn on the power and check that sound can be heard.
	No sound can be heard if the muting function of the Application is activated.
	The muting function is activated also when headphones are used. Check that muting is turned off. Mute function details
	No sound comes from the speakers if headphones are connected to the headphone jack. Disconnect the headphones from the headphone jack in order to hear sound from the speakers.
	No sound can be heard if the volume control is set too low. Adjust the volume and check again. Volume adjustment details
	No sound will be heard if playback is not started on audio equipment connected to the RP-U100 or music play software running on the PC. Check that playback is in progress on the audio equipment or computersoftware.
	Broadcast stations will be difficult to hear if tuner reception is poor or tuning was not correctly performed. Refer to the Tuner Panel page for information on how to tune into a station. For information on antenna connection and related items, please refer to the instruction manual of the RP-U100.
No sound is produced if the audio wiring or USB cable are not connected correctly. Check that the connections to each audio device and to the personal computer are correct.	
No sound from computer although PC input is selected.	When PC_DIGITAL or PC_ANALOG is selected for the PC input, the sound may sometimes not be output or may be difficult to hear, due to the USB mix level setting. Refer to the USB MIX LEVEL setting on the setup Panel for a detailed explanation. Setup Dialog: USB MIX LEVEL details
Different sounds are heard together.	Sound from the PC via USB cable may be mixed with sound from other sources due to the USB MIX LEVEL setting on the Setup Dialog. Change the USB MIX LEVEL setting on the Setup Dialog. Select MIX OFF if you do not want to hear other sound sources with the PC audio. Refer to Setup Dialog: USB MIX LEVEL details.
Volume indicator won't move all the way.	The upper volume limit for the application can be changed with MAX VOL POSITION on the setup dialog. The default setting is half a rotation (50%). Changing the MAX VOL POSITION setting allows the volume indicator to move more than halfway (from 50 to 90%). Refer to Setup Dialog: MAX VOL POSITION details.

<p>Left and right volume levels are different.</p>	<p>The right and left volume levels will be different if the level balance is not set to center in the Virtual 3D Parameter Setting Panel. Check the Balance setting. Virtual 3D parameter setting Panel: Balance details</p>
<p>Cannot record with USB capture.</p>	<p>Recording is not possible if the settings on the recording software running on the computer are incorrect. Refer to the description page for USB capture when making the data recording settings. Refer to the USB capture details</p>

[Problem with Windows]

In case of problems with Windows, refer to "[Windows Help](#)" or check the Windows documentation.

Latest Information

RP-U100 Latest Information

Up-to-date information on this product can be obtained at the site listed below.

<p>YAMAHA Consumer Electronics</p>	<p>http://www.yamaha.com/yec/</p>
--	--

Uninstall

RP-U100 Uninstall Procedure

(1) Quit the RP-U100 Application

! Also close the help screen (RP-U100 Help) when you start the uninstall.

(2) Open the control panel.



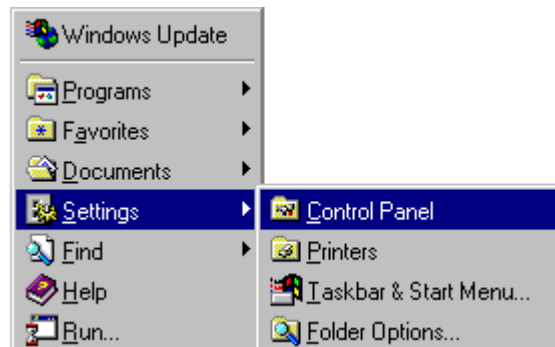

(3) Double Click the "Add/Remove Programs" icon.



(4) Use "Add/Remove Programs Properties: [Install/Uninstall]" to delete the RP-U100 application.

! Start the uninstall with the RP-U100 application closed and this help page (RP-U100 Help) closed.

☰ Select "YAMAHA RP-U100" and click Add/Remove.

! If uninstall is performed while the RP-U100 application or help are open, the application and help files will not be fully uninstalled.

In this case, close the RP-U100 application and help, and manually delete the RP-U100 install folder.

